

A nighttime city skyline with several skyscrapers illuminated against a dark sky. In the foreground, there are vibrant, blurred light trails in shades of orange, red, and white, suggesting motion or a futuristic theme.

C Simon

Fire Protection System
User Manual





CSimon User Manual

30577 Rev 4

Revised December 2024

©2024 Computrols, Inc. All rights reserved.

www.computrols.com

504.529.1413

2520 Belle Chasse Highway

Gretna, Louisiana 70053

Section 1.0 » Introduction.....	1
1.1 Description.....	1
1.2 System Operation.....	1
1.3 Maximum Devices	2
1.4 Ordering Information.....	2
1.5 Features	2
1.5.1 Ground Faults.....	2
1.6 System Components	3
1.6.1 Fire Controller	3
1.6.2 Terminal Board.....	3
1.6.3 Enclosure.....	3
1.6.4 Brain Board	3
1.6.5 2-Channel Signaling Line Circuits.....	3
1.6.6 Power Supply.....	3
1.6.7 Battery Backup	4
1.6.8 User Interface	4
1.6.9 Printer	4
1.6.10 Transformer	4
1.6.11 Batteries	4
1.6.12 Battery Calculations.....	4
1.7 Bases (Optional)	8
1.7.1 XP95ABase (45681-210)	8
1.7.2 XP95A E-Z Fit Base (45681-250).....	8
1.7.3 Apollo Soteria UL Base – 4” (SA5000-210)	8
1.7.4 Apollo Soteria UL Base – 6” (SA5000-230)	8
1.7.5 Apollo Soteria UL HF Sounder Base – 6” (SA5300-802)	8
1.7.6 Apollo Soteria UL LF Sounder Base – 6” (SA5300-806)	8
1.8 Detectors (Optional).....	8
1.8.1 Apollo Discovery Ionization Monitor (58000-550).....	8
1.8.2 Apollo Discovery Optical Monitor (58000-650)	8
1.8.3 Apollo Discovery Heat Detector (58000-450)	9
1.8.4 Apollo Discovery Multisensor (58000-750).....	9

1.8.5 Apollo XP95A Beam Detector (55000-266)	9
1.8.6 Apollo Soteria UL Smoke Detector (SA5150-650)	9
1.8.7 Apollo Discovery/Soteria UL Heat Detector (SA5800-450)	9
1.8.8 Apollo Soteria UL Multi-Criteria Detector (SA5150-750)	9
1.8.9 Apollo XP95A Smoke Detector (SA5050-250)	9
1.8.10 Apollo XP95A Multi-Criteria Detector (SA5050-350)	10
1.8.11 Apollo XP95A Heat Detector (SA5500-450)	10
1.9 Monitor/Control Modules (Optional)	10
1.9.1 Apollo XP95A Priority Switch Monitor Module (55000-806)	10
1.9.2 Apollo XP95A Sounder Control Module (55000-825)	10
1.9.3 Apollo XP95A Mini Switch Monitor Module (55000-831)	10
1.9.4 Apollo XP95A Switch Monitor Module (55000-805)	10
1.9.5 Apollo XP95A Switch Monitor I/O Module (55000-820)	10
1.9.6 Apollo XP95A Mini Priority Switch Monitor Module (55000-830)	11
1.9.7 Apollo Discovery Sounder Beacon Base (45681-524)	11
1.9.8 Apollo Analog Add. Duct Detector Ionization (SL-DAA-N)	11
1.9.9 Apollo Analog Add. Duct Detector Photoelectric (SL-DAA-P)	11
1.9.10 Apollo Soteria UL Switch Monitor Module (SA4705-700)	13
1.9.11 Apollo Soteria UL Mini Switch Module (SA4705-600)	13
1.9.12 Apollo Soteria UL Switch Monitor Input/Output Module (SA4705-703)	13
1.9.13 Apollo Soteria UL NAC Module (SA4705-706)	13
1.9.14 Apollo XP95A Input/Output Module – 120Vac (55000-859)	13
1.9.15 FCI Monitor Module (AMM-4)	11
1.9.16 FCI Mini Monitor Module (AMM-2)	11
1.9.17 FCI Control Module (AOM-2S)	11
1.9.18 FCI Relay Control Module (AOM-2R)	11
1.9.19 FCI Zone Monitor Module (AMM-4S)	11
1.9.20 Edwards Monitor Module (M500MF)	11
1.9.21 Edwards Mini Monitor Module (M501MF)	11
1.9.22 Edwards Relay Control Module (M500RF)	12
1.9.23 Edwards Control Module (M500SF)	12
1.9.24 Notifier Monitor Module (FMM-1)	12
1.9.25 Notifier Mini Monitor Module (FMM-101)	12
1.9.26 Notifier Relay Control Module (FRM-1)	12
1.9.27 Notifier Control Module (FCM-1)	12
1.9.28 Notifier Zone Monitor Module (FZM-1)	12
1.9.29 Fire-Lite Monitor Module (MMF-300 (old part # M300))	12
1.9.30 Fire-Lite Mini Monitor Module (MMF-301 (old part # M301))	12

1.9.31 Fire-Lite Relay Control Module (CRF-300 (old part #C304))	12
1.9.32 Fire-Lite Control Module (CMF-300 (old part #C304))	12
1.9.33 Fire-Lite Zone Monitor Module (MMF-302)	12
1.9.34 Honeywell Monitor Module (TC809A1058)	13
1.9.35 Honeywell Relay Control Module (TC810R1024)	13
1.9.36 Honeywell Control Module (TC810N1013)	13
1.10 Accessories	13
1.10.1 Computrols SC1	13
1.10.2 Precon Encapsulated Thermistor Sensor	13
Section 2.0 » Database Setup Using CBAS	14
2.1 Commissioning Hardware Diagram	14
2.2 Software Setup	15
2.2.1 Create New Database	15
2.2.2 Adding Panels	16
2.2.3 Adding a Slave Panel	18
2.2.4 Viewing Points	19
2.2.5 Adding Detectors and Modules	20
2.2.6 Commanding and Programming Points	22
2.2.7 Groups and Group Membership	24
2.2.8 Program Fire Groups	25
2.2.9 Program Fire Points	26
2.2.10 Import Fire Points	27
2.2.11 Adding a Computrols SC1 to the System	28
2.3 Remote Panels	29
Section 3.0 » User Interface Operation	31
3.1 Keypad Operations	31
3.1.1 Point	32
3.1.2 Group	33
3.1.3 Walk Test	33
3.1.4 System	33
3.2 Passcodes	34
3.2.1 Acknowledge	36
3.2.2 Reset	36
3.2.3 Silence	36
3.2.4 Lamp Test	36
3.2.5 Commission Mode	36

Section 4.0 » Terminal Descriptions/Installation Instructions	37
4.1 Terminal Description with Installation Instructions	37
4.1.1 Alarm No/Alarm Common	37
4.1.2 Alarm NC/Alarm Common.....	37
4.1.3 Trouble No/Trouble Common.....	38
4.1.4 Trouble NC/Trouble Common	38
4.1.5 F Dept No/F Dept Common	38
4.1.6 F Dept NC/F Dept Common.....	38
4.1.7 Cen St No/Cen St Common	39
4.1.8 Cen St NC/Cen St Common	39
4.1.9 Binary Output/Binary Common	39
4.1.10 Temp (Cabinet/Battery) (Optional).....	40
4.1.11 Host +, -, Shield.....	40
4.1.12 SECONDARY +, -, SHIELD	40
4.1.13 USER INTERFACE.....	40
4.1.14 SLC + (A, B).....	40
4.1.15 SLC – (A, B).....	41
4.1.16 Printer Port (RX, TX, GND, RTS, CTS, GND).....	41
4.1.17 Local BUS (+, -, S).....	41
4.1.18 Battery +/Battery	41
4.1.19 Battery Disconnect Switch	41
4.1.20 24VAC ~ /	41
4.1.21 24VDC Regulated/DC Common	41
4.1.22 24VDC Unregulated / DC Common.....	41
4.1.23 10Mbit Port.....	41
4.1.24 Enclosure Door Hinge Relocation	42
4.2 System Diagrams	43
4.2.1 System Monitoring Diagram.....	43
4.2.2 Installation/Wiring Diagram	44
4.2.3 Sample Topologies	46
 Section 5.0 » System Maintenance	 48
5.1 Control Equipment.....	48
5.2 Secondary (Standby) Power Supply.....	48
5.3 Batteries	49
5.4 Battery Tests	49
5.5 Public Reporting System Tests	49
5.6 Transient Suppressors	50

5.7 Control Unit Trouble Signals.....	50
5.8 Conductors — Metallic	51
5.9 Conductors — Nonmetallic.....	51
5.10 Initiating Devices.....	52
5.11 Special Hazard Equipment	54
5.12 Supervising Station Fire Alarm Systems — Receiving Equipment.....	54

Section 1.0 »

Introduction

1.1 Description

The Fire System consists of 5 Signaling Loop Circuit (SLC) Modules with 2 channels per module used for Class A configuration (only 1 channel for Class B configuration), 2 Power Supply Modules, 1 Battery Backup Module, 1 Brain Module and 1 User Interface Module all attached to a Terminal Board via DIN connectors and ribbon cables. The communications between each module is RS 485 and is referred to Local RS 485 bus port. The Terminal Board with all of these modules attached is mounted in a UL listed custom panel enclosure. The Terminal Board consists of 1 RS-232 printer port, 10 SLC ports, 4 relays contacts (NO and NC), 3 nonspecific 24VDC outputs, 2 temperature sensor inputs used to monitor cabinet and battery temperature, 2 RS-485 panel ports, 1 Local RS 485 bus port, 1 set of battery input terminals and 1 set of 24VAC input terminals. The Brain Module includes a 10Mbit port. This will be used to connect to a PC for additional monitoring and for setting the initial database for the Fire System. There is a variety of third party equipment that will wire to some of these ports. This equipment is listed in Section 1.2.

1.2 System Operation

When an alarm occurs on a zone, the control panel indicates the alarm condition at the panel by sounding an audible signal and by flashing a red alarm LED until manually reset.

An alarm may be acknowledged by pressing the “ACK” button on the User Interface. This shall silence the panel sounder and change the status of the “Alarm LED” and the individual “Zone LED” from flashing to steady.

In the event of a microprocessor failure, the system will execute a default signaling program, which will enable the panel to operate the notification appliances and notify the Fire Department through the on board “Fire Dept” notification relay. It has normally open and normally closed relay contacts, which are software programmable to switch upon any alarm condition. The “Fire Dept” notification relay is designed for connection to a UL listed Digital Alarm Communicator Transmitter (DACT). See Section 4.1.5.

1.3 Maximum Devices

Class A & B	5 Signaling Line Circuit (SLC) per fire panel
APOLLO Signaling Line Circuit (SLC)	126 devices [detectors or (control, monitor, relay, I/O) modules]
FCI, Notifier, Honeywell, Fire-Lite, Edwards Signaling Line Circuit (SLC)	126 (control, monitor, relay) modules

1.4 Ordering Information

BUILD A PART NUMBER

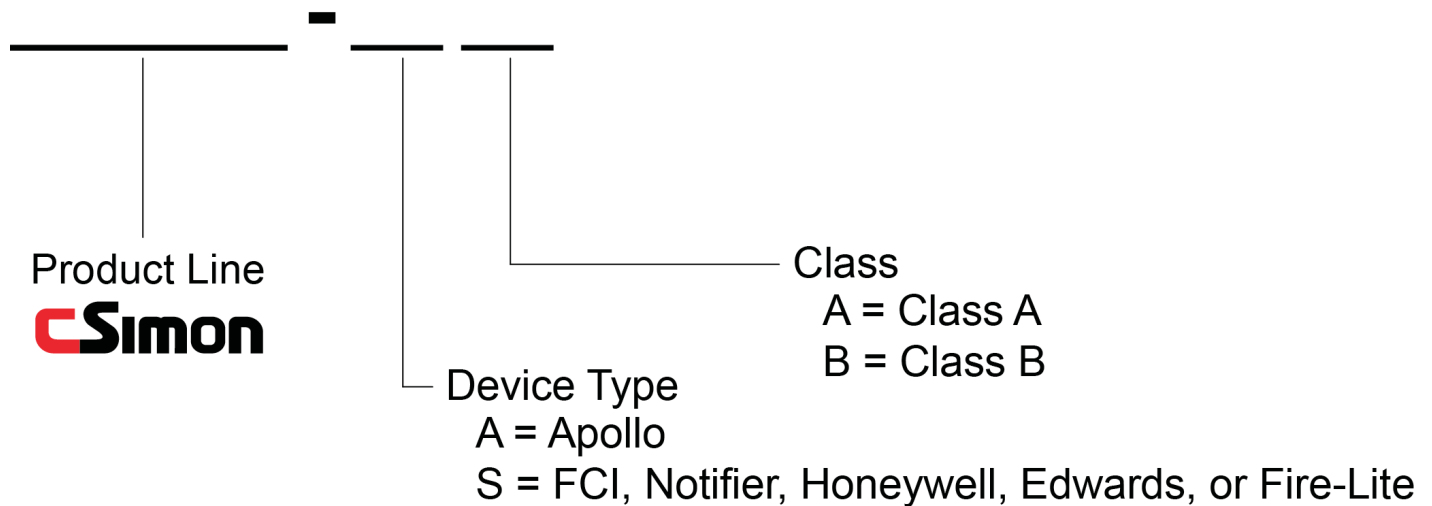

Sample Part Number

CSimon - AA

(This part number represents **CSimon** Apollo, Class A)

1.5 Features

1.5.1 Ground Fault

All Ground Fault detection ties through Earth Ground.

1.6 System Components

1.6.1 Fire Controller

1.6.2 Terminal Board

The terminal board is the “motherboard” for the entire fire controller. It consists of many terminals described in Section 3.0. It has a RS 485 backbone for each module to be on the same communication trunk.

1.6.3 Enclosure

The enclosure consists of a box with cut-out to access the User Interface (Section 1.6.8) via password protection and a full access cabinet door accessible with a keylock. It is made of 14-gauge steel and contains various knockouts and vents. When opened, the full access cabinet door allows the user to access everything in the cabinet including all modules, terminations, batteries, transformers, etc.

1.6.4 Brain Board

The brain board contains an Intel 386 Processor, which stores the entire database for the fire system. When the fire system is initially installed, this database will be set-up via Ethernet. This is explained in Section 2.0. However, once the database is programmed, the fire controller is completely standalone and can function fully without the Ethernet connection.

1.6.5 2-Channel Signaling Line Circuits

The 2-Channel Signaling Line Circuit (SLC) provides communication with all analog addressable devices including the devices listed in 1.8 and 1.9. There are a maximum of five 2-channel SLC modules per fire panel. Each module has two channels to be wired as Class B (using both channels on a SLC) or Class A (using only 1 channel per SLC). Each channel can accommodate 126 addressable points. These SLC's are intrinsically power limited.

- » SLC Output Voltage: 21.8 to 21.8 Volts DC
- » SLC Max current = 300mA
- » SLC Impedance = 8 Ohms

The CSimon comes in different models. It can be set up to use either devices manufactured by APOLLO listed in section 1.8 or it can be set up to use devices manufactured by FCI, Honeywell, Edwards, Notifier and Fire-Lite listed in section 1.9.

1.6.6 Power Supply

A single Power Supply module outputs the 5 amps of current. However, the Fire System allows an optional second power supply to be placed in parallel to output a total of 10 amps. This module converts 24 Volts AC taken from the transformer to 33.8 volts DC unregulated and then to 24 volts DC regulated, 8 volts DC regulated and 5 volts DC regulated.

The ratings are as follows:

- » 120 Vac, 60 Hz, Max. Current Draw @ NS = 1.07A
- » 120 Vac, 60 Hz, Max. Current Draw @ A = 1.905A

1.6.7 Battery Backup

The Battery Backup module charges the Power Sonic Re-chargeable Sealed Lead-Acid Batteries (see section 1.6.11) when the main power transformer is feeding the fire system. However, when the main power transformer is not feeding the fire system with its required power for any reason, the Battery Backup module switches the batteries into the circuit to feed the entire system.

1.6.8 User Interface

The User Interface Module consists of a keypad, LCD and LED's. It allows the user with the password to access the keypad and to fully operate the fire system. The User Interface Operations are explained in section 3.0.

1.6.9 Printer

The printer is a Keltron 90 Series Fire Alarm Printer. It prints alarms and troubles and provides a "hard copy" as opposed to an electronic message for the fire system. It prints the alarms and troubles on a roll of 3 inch wide paper. This paper should be maintained at all times by monitoring the paper status LEDs. (Refer to Keltron's 90 Series Fire Alarm Printer installation manual for installation instructions.)

1.6.10 Transformer

The transformer input is 110/220VAC. The output is 28VAC @ 6.2Amps. This transformer is factory installed. (Refer to Triad Magnetics' part number VPS28-6250 installation manual for further information.)

1.6.11 Batteries

The batteries are rechargeable sealed lead-acid batteries by Power Sonic. They are 12 volt, 55 amp-hours needed for max load. The part number is PS-12550. These are factory installed. (Refer to Power Sonic's part number PS-12550 installation manual for further information.) When the AC voltage drops below 103 Volts the FIRE system will switch to Battery. The FIRE system will switch back to AC power after the AC voltage has been above 106V for 5 seconds.

When AC power is lost the FIRE system will switch to Battery. The system will continue to run from the Battery until the battery voltage drops to a point where it can no longer run the system (or until the AC voltage comes back on for 100 seconds). BUT, the FIRE system will not start from the Battery. This means that if the system is running from Battery and someone flips the Battery Disconnect switch or disconnects the battery, the FIRE system will STAY POWERED DOWN UNTIL AC VOLTAGE IS REAPPLIED even if the Battery Disconnect switch is flipped back or the battery is reconnected. There is NO WAY to get the FIRE system back up in an AC outage once the battery has been disconnected until the AC power is back.

1.6.12 Battery Calculations

The battery backup must last for 24 hours in standby mode and 5 minutes in Alarm mode as per NFPA72 4.4.1.5.3.1 (2002 Edition). Use the chart and formula on the following page to calculate the battery required.

Device Manufacturer	Device Name	Device Part No.	Quantity	Alarm Current (amps)	Standby Current (amps)	Total Alarm Current [Q x Alarm Current] (amps)	Total Standby Current [Q x Standby Current] (amps)
APOLLO	Discovery Ionization Monitor	58000-550		0.0035	0.0005		
APOLLO	Discovery Optical Monitor	58000-650		0.0034	0.0004		
APOLLO	Discovery Heat Detector	58000-450		0.0034	0.0005		
APOLLO	Discovery Multisensor	58000-750		0.0035	0.0005		
APOLLO	XP95A Beam Detector	55000-266		0.018	0.0165		
APOLLO	Soteria UL Smoke Detector	SA5150-650		0.004	0.0005		
APOLLO	Discovery/Soteria UL Heat Detector	SA5800-450		0.0035	0.0005		
APOLLO	Soteria UL Multi-Criteria Detector	SA5150-750		0.004	0.0005		
APOLLO	XP95A Smoke Detector	SA5050-250		0.004	0.00034		
APOLLO	XP95A Multi-Criteria Detector	SA5050-350		0.004	0.00034		
APOLLO	XP95A Heat Detector	SA5500-450		0.003	0.00025		
APOLLO	XP95A Priority Switch Monitor Module	55000-805		0.005	0.0006		
APOLLO	XP95A Sounder Control Module	55000-825		0.004	0.001		
APOLLO	XP95A Mini Switch Monitor Module	55000-831		0.005	0.0006		
APOLLO	XP95A Switch Monitor Module	55000-805		0.005	0.0006		
APOLLO	XP95A Switch Monitor I/O Module	55000-820		0.005	0.00065		
APOLLO	XP95A Mini Priority Switch Monitor Module	55000-830		0.005	0.0006		
APOLLO	Discovery Sounder Beacon Base	45681-524		0.00636	0.0013		
APOLLO	Analog Addressable Duct Detector (Ionization)	SL-DAA-N		0.0025	0.00028		
APOLLO	Analog Addressable Duct Detector (Photoelectric)	SL-DAA-P		0.0045	0.00034		
APOLLO	Soteria UL Switch Monitor Module	SA4705-700		0.0016	0.0005		
APOLLO	Soteria UL Mini Switch Module	SA4705-600		0.0016	0.0005		
APOLLO	Soteria UL Switch Monitor Module Input/Output Module	SA4705-703		0.0016	0.0005		
APOLLO	Soteria UL NAC Module	SA4705-706		0.0016	0.0005		
APOLLO	XP95A Input/Output Module	55000-859		0.005	0.00095		
FCI	Monitor Module	AMM-4		0.00575	0.0004		
FCI	Mini Monitor Module	AMM-2		0.0006	0.0004		
FCI	Control Module	AOM-2S		0.0003	0.0003		
FCI	Relay Control Module	AOM-2R		0.0003	0.0003		
FCI	Zone Monitor Module	AMM-4S		0.0003	0.0003		
EDWARDS	Monitor Module	M500MF		0.0051	0.000375		
EDWARDS	Mini Monitor Module	M501MF		0.000375	0.000375		
EDWARDS	Relay Control Module	M500RF		0.0051	0.000375		
EDWARDS	Control Module	M500SF		0.0051	0.000255		
NOTIFIER	Monitor Module	FMM-1		0.0051	0.000375		
NOTIFIER	Mini Monitor Module	FMM-101		0.000375	0.000375		
NOTIFIER	Relay Control Module	FRM-1		0.0065	0.000375		
NOTIFIER	Control Module	FCM-1		0.0065	0.000255		
NOTIFIER	Zone Monitor Module	FZM-1		0.0065	0.000255		
FIRE-LITE	Monitor Module	MMF-300		0.0051	0.0004		
FIRE-LITE	Mini Monitor Module	MMF-301		0.000375	0.000375		
FIRE-LITE	Relay Control Module	CRF-300		0.0051	0.00027		
FIRE-LITE	Control Module	CMF-300		0.0051	0.00039		
FIRE-LITE	Zone Monitor Module	MMF-302		0.0051	0.00039		
HONEYWELL	Monitor Module	TC809A1058		0.0051	0.000375		
HONEYWELL	Relay Control Module	TC810R1024		0.0051	0.000375		
HONEYWELL	Control Module	TC810N1013		0.0051	0.000375		
COMPUTROLS	Supervisory	SC1		0.5000	0.5000		
PRECON	Encapsulated Thermistor Sensor	ST-R3		0.005	0.005		
KELTRON	90 Series Fire Alarm Printer	VS4095/5 w/ VS ENCRD		1.0000	0.1000		
TOTALS						(Sum of Alarm Currents)	(Sum of Standby Currents)

Ampere-hours needed during STANDBY phase:

(0.36 + Sum of Standby Currents) Amperes x 24 Hours

Ampere-hours needed during ALARM phase:

(0.36 + Sum of Alarm Currents) Amperes x 0.084¹ Hours

Total amp hours requirement:

$\{[(0.36 + \text{Sum of Standby Currents}) \times 24] + [(0.36 + \text{Sum of Alarm Currents}) \times 0.084]\} \times 1.2^2$

Example calculation with:

- » 12 APOLLO Discovery Ionization Monitors
- » 5 APOLLO Discovery Optical Monitors
- » APOLLO XP95A Switch Monitor Modules

1 5 minutes = 0.084 Hours

2 20% overrating factor for safety

» 1 APOLLO XP95A Switch Monitor I/O Module:

Device Manufacturer	Device Name	Device Part No.	Quantity	Alarm Current (amps)	Standby Current (amps)	Total Alarm Current [Q x Alarm Current] (amps)	Total Standby Current [Q x Standby Current] (amps)
APOLLO	Discovery Ionization Monitor	58000-550		0.0035	0.0005	0.042	0.006
APOLLO	Discovery Optical Monitor	58000-650		0.0034	0.0004	0.017	0.002
APOLLO	Discovery Heat Detector	58000-450		0.0034	0.0005	0	0
APOLLO	Discovery Multisensor	58000-750		0.0035	0.0005	0	0
APOLLO	XP95A Beam Detector	55000-266		0.018	0.0165	0	0
APOLLO	Soteria UL Smoke Detector	SA5150-650		0.004	0.0005	0	0
APOLLO	Discovery/Soteria UL Heat Detector	SA5800-450		0.0035	0.0005	0	0
APOLLO	Soteria UL Multi-Criteria Detector	SA5150-750		0.004	0.0005	0	0
APOLLO	XP95A Smoke Detector	SA5050-250		0.004	0.00034	0	0
APOLLO	XP95A Multi-Criteria Detector	SA5050-350		0.004	0.00034	0	0
APOLLO	XP95A Heat Detector	SA5500-450		0.003	0.00025	0	0
APOLLO	XP95A Priority Switch Monitor Module	55000-806		0.005	0.0006	0	0
APOLLO	XP95A Sounder Control Module	55000-825		0.004	0.001	0	0
APOLLO	XP95A Mini Switch Monitor Module	55000-831		0.005	0.0006	0	0
APOLLO	XP95A Switch Monitor Module	55000-805		0.005	0.0006	0.01	0.0012
APOLLO	XP95A Switch Monitor I/O Module	55000-820		0.005	0.00065	0.005	0.00065
APOLLO	XP95A Mini Priority Switch Monitor Module	55000-830		0.005	0.0006	0	0
APOLLO	Discovery Sounder Beacon Base	45681-524		0.00636	0.0013	0	0
APOLLO	Analog Addressable Duct Detector (Ionization)	SL-DAA-N		0.0025	0.00028	0	0
APOLLO	Analog Addressable Duct Detector (Photoelectric)	SL-DAA-P		0.0045	0.00034	0	0
APOLLO	Soteria UL Switch Monitor Module	SA4705-700		0.0016	0.0005	0	0
APOLLO	Soteria UL Mini Switch Module	SA4705-600		0.0016	0.0005	0	0
APOLLO	Soteria UL Switch Monitor Module Input/Output Module	SA4705-703		0.0016	0.0005	0	0
APOLLO	Soteria UL NAC Module	SA4705-706		0.0016	0.0005	0	0
APOLLO	XP95A Input/Output Module	55000-859		0.005	0.00095	0	0
FCI	Monitor Module	AMM-4		0.00575	0.0004	0	0
FCI	Mini Monitor Module	AMM-2		0.0006	0.0004	0	0
FCI	Control Module	AOM-2S		0.0003	0.0003	0	0
FCI	Relay Control Module	AOM-2R		0.0003	0.0003	0	0
FCI	Zone Monitor Module	AMM-4S		0.0003	0.0003	0	0
EDWARDS	Monitor Module	M500MF		0.0051	0.000375	0	0
EDWARDS	Mini Monitor Module	M501MF		0.000375	0.000375	0	0
EDWARDS	Relay Control Module	M500RF		0.0051	0.000375	0	0
EDWARDS	Control Module	M500SF		0.0051	0.000255	0	0
NOTIFIER	Monitor Module	FMM-1		0.0051	0.000375	0	0
NOTIFIER	Mini Monitor Module	FMM-101		0.000375	0.000375	0	0
NOTIFIER	Relay Control Module	FRM-1		0.0065	0.000375	0	0
NOTIFIER	Control Module	FCM-1		0.0065	0.000255	0	0
NOTIFIER	Zone Monitor Module	FZM-1		0.0065	0.000255	0	0
FIRE-LITE	Monitor Module	MMF-300		0.0051	0.0004	0	0
FIRE-LITE	Mini Monitor Module	MMF-301		0.000375	0.000375	0	0
FIRE-LITE	Relay Control Module	CRF-300		0.0051	0.00027	0	0
FIRE-LITE	Control Module	CMF-300		0.0051	0.00039	0	0
FIRE-LITE	Zone Monitor Module	MMF-302		0.0051	0.00039	0	0
HONEYWELL	Monitor Module	TC809A1058		0.0051	0.000375	0	0
HONEYWELL	Relay Control Module	TC810R1024		0.0051	0.000375	0	0
HONEYWELL	Control Module	TC810N1013		0.0051	0.000375	0	0
COMPUTROLS	Supervisory	SC1		0.5000	0.5000	0	0
PRECON	Encapsulated Thermistor Sensor	ST-R3		0.005	0.005	0	0
KELTRON	90 Series Fire Alarm Printer	VS4095/5 w/ VS ENCREd		1.0000	0.1000	0	0
TOTALS						0.074	0.01005

Example Total Amp-Hour requirement:

$$\{[(0.36 + 0.01005) \times 24] + [(0.36 + 0.074) \times 0.084]\} \times 1.2 = 10.701$$

1.7 Bases (Optional)

1.7.1 XP95A Base (45681-210)

The XP95A base has been designed to enable the detector to be fitted without the need for any force. (Refer to Apollo Fire Detectors Limited's part number 58000-650 installation manual for installation instructions.)

1.7.2 XP95A E-Z Fit Base (45681-250)

The XP95A E-Z Fit base is an ultra-low profile mounting base for XP95A and Discovery smoke and heat detectors and can be fitted to mounting boxes up to 4in (100mm) in size. (Refer to Apollo Fire Detectors Limited's part number 45681-250 installation manual for installation instructions.)

1.7.3 Apollo Soteria UL Base – 4” (SA5000-210)

The Soteria UL base is an easy fit 4” base that supports isolated Soteria UL and non-isolated XP95A detectors. (Refer to Apollo Fire Detectors Limited's part number SA5000-210 installation manual for installation instructions.)

1.7.4 Apollo Soteria UL Base - 6” (SA5000-230)

The Soteria UL base is an easy fit 6” base that supports isolated Soteria UL and non-isolated XP95A detectors. (Refer to Apollo Fire Detectors Limited's part number SA5000-230 installation manual for installation instructions.)

1.7.5 Apollo Soteria UL HF Sounder Base – 6” (SA5300-802)

The Soteria UL HF Sounder base is a high frequency sounder base compatible with Apollo analog addressable detectors with the XP95A and Soteria UL series. (Refer to Apollo Fire Detectors Limited's part number SA5300-802 installation manual for installation instructions.)

1.7.6 Apollo Soteria UL LF Sounder Base - 6” (SA5300-806)

The Soteria UL LF sounder is a low frequency 520Hz sounder base compatible with Soteria UL and non-isolated XP95A detectors. (Refer to Apollo Fire Detectors Limited's part number SA5300-806 installation manual for installation instructions.)

1.8 Detectors (Optional)

1.8.1 Apollo Discovery Ionization Monitor (58000-550)

Ionization chamber smoke detectors irradiate the air in the polarized smoke chamber, which creates a current flow. Smoke entering the chamber causes a current flow to be reduced and this creates an alarm condition.

It is a good general-purpose detector that responds well to fast burning, flaming fires. Some common applications include hotel rooms, studio apartments, offices, long corridors, hospital wards, light industrial factory units, warehouses and bars. These modules can be used with either the XP95A Isolator Base 20D or XP95A EZ Fit Base. (Refer to Apollo Fire Detectors

Limited's part number 58000-550 installation manual for installation instructions.)

1.8.2 Apollo Discovery Optical Monitor (58000-650)

The Discovery optical smoke detector is suitable for slow burning or smoldering fires and should be positioned where these are most likely to occur. They can be set to a sensitivity mode best suited for the application. Some common applications include suites, hotel rooms, studio apartments, offices, long corridors, hospital wards, light industrial factory units, warehouses, bars, loading bays, car parks and boiler rooms. These modules can be used with either XP95A Isolator Base 20D or XP95A EZ Fit Base. (Refer to Apollo Fire Detectors Limited's part number 58000-650 installation manual for installation instructions.)

1.8.3 Apollo Discovery Heat Detector (58000-450)

The Discovery heat detector uses a single thermistor to sense the air temperature around the detector. This type of detector is particularly useful where the environment is dirty or smoky under normal conditions. Some common applications are kitchens, laundry rooms and boiler rooms. These modules can be used with either XP95A Isolator Base 20D or XP95A EZ Fit Base. (Refer to Apollo Fire Detectors Limited's part number 58000-450 installation manual for installation instructions.)

1.8.4 Apollo Discovery Multisensor (58000-750)

The Discovery multisensor detector is an optical smoke detector and temperature sensor whose outputs are combined to give the final analog value. As a result, the multisensor is useful over a wide range of applications and is highly immune to false alarms. Some common applications include suites, hotel rooms, studio apartments, warehouses, bars, loading bays or car parks. These modules can be used with either XP95A Isolator Base 20D or XP95A EZ Fit Base. (Refer to Apollo Fire Detectors Limited's part number 58000-750 installation manual for installation instructions.)

1.8.5 Apollo XP95A Beam Detector (55000-266)

The XP95A beam detector has been designed to protect large open spaces such as atria, museums, churches, warehouses and factories. It is made up of three main parts: the transmitter, which projects a beam of infrared light, the receiver, which registers the light and produces an electrical signal, and the interface, which processes the signal and generates alarm or fault signals. (Refer to Apollo Fire Detectors Limited's part number 55000-266 installation manual for installation instructions.)

1.8.6 Apollo Soteria UL Smoke Detector (SA5150-650)

The Soteria smoke detector employs a new photoelectric sensing technology to detect smoke particles entering the chamber, significantly minimizing the chance of false alarms. This detector is a direct replacement for the 58000-650 Discovery UL Smoke Detector. (Refer to Apollo Fire Detectors Limited's part number SA5150-650 installation manual for installation instructions.)

1.8.7 Apollo Discovery/Soteria UL Heat Detector (SA5800-450)

The Discovery/Soteria heat detector uses a single thermistor to sense the air temperature around the detector. This detector is a direct replacement for the 58000-450 Discovery UL Heat Detector. (Refer to Apollo Fire Detectors Limited's part number SA5800-450 installation

manual for installation instructions.)

1.8.8 Apollo Soteria UL Multi-Criteria Detector (SA5150-750)

The Soteria multi-criteria detector employs a new photoelectric sensing technology to detect smoke particles entering the chamber and is equipped with two thermistors for heat detection. This detector is a direct replacement for the 58000-750 Discovery UL Multisensor Detector. (Refer to Apollo Fire Detectors Limited's part number SA5150-750 installation manual for installation instructions.)

1.8.9 Apollo XP95A Smoke Detector (SA5050-250)

The XP95A smoke detector employs a new photoelectric sensing technology to identify smoke particles entering the chamber. This enhances detection reliability for actual fires while reducing the likelihood of false alarms. This smoke detector is backwards compatible with XP95 systems and is a direct replacement for the 55000-650 XP95A smoke detector. (Refer to Apollo Fire Detectors Limited's part number SA5050-250 installation manual for installation instructions.)

1.8.10 Apollo XP95A Multi-Criteria Detector (SA5050-350)

The XP95A multi-criteria detector employs a new photoelectric sensing technology to identify smoke particles entering the chamber and is equipped with dual exposed heat sensing elements. This multi-criteria detector is compatible with XP95A systems. (Refer to Apollo Fire Detectors Limited's part number SA5050-350 installation manual for installation instructions.)

1.8.11 Apollo XP95A Heat Detector (SA5500-450)

The XP95A heat detector measures temperature using a single thermistor that generates a voltage output proportional to the external air temperature. This heat detector is compatible with XP95A systems and is a direct replacement for the 55000-450 XP95A heat detector. (Refer to Apollo Fire Detectors Limited's part number SA5500-450 installation manual for installation instructions.)

1.9 Monitor/Control Modules (Optional)

1.9.1 Apollo XP95A Priority Switch Monitor Module (55000-806)

(Refer to Apollo Fire Detectors Limited's part number 55000-806 installation manual for installation instructions.)

1.9.2 Apollo XP95A Sounder Control Module (55000-825)

(Refer to Apollo Fire Detectors Limited's part number 55000-825 installation manual for installation instructions.)

1.9.3 Apollo XP95A Mini Switch Monitor Module (55000-831)

(Refer to Apollo Fire Detectors Limited's part number 55000-831 installation manual for installation instructions.)

1.9.4 Apollo XP95A Switch Monitor Module (55000-805)

(Refer to Apollo Fire Detectors Limited's part number 55000-805 installation manual for

installation instructions.)

1.9.5 Apollo XP95A Switch Monitor I/O Module (55000-820)

The ratings for the I/O Module:

- » 120 Vac, 60 Hz, Max. Current Draw @ NS = 208 mA
- » 120 Vac, 60 Hz, Max. Current Draw @ A = 211 mA

(Refer to Apollo Fire Detectors Limited's part number 55000-820 installation manual for installation instructions.)

1.9.6 Apollo XP95A Mini Priority Switch Monitor Module (55000-830)

(Refer to Apollo Fire Detectors Limited's part number 55000-830 installation manual for installation instructions.)

1.9.7 Apollo Discovery Sounder Beacon Base (45681-524)

(Refer to Apollo Fire Detectors Limited's part number 45681-524 installation manual for installation instructions.)

1.9.8 Apollo Analog Add. Duct Detector Ionization (SL-DAA-N)

(Refer to Apollo Fire Detectors Limited's part number SL-DAA-N installation manual for installation instructions.)

1.9.9 Apollo Analog Add. Duct Detector Photoelectric (SL-DAA-P)

(Refer to Apollo Fire Detectors Limited's part number SL-DAA-P installation manual for installation instructions.)

1.9.10 Apollo Soteria UL Switch Monitor Module (SA4705-700)

(Refer to Apollo Fire Detectors Limited's part number SA4705-700 installation manual for installation instructions.)

1.9.11 Apollo Soteria UL Mini Switch Module (SA4705-600)

(Refer to Apollo Fire Detectors Limited's part number SA4705-600 installation manual for installation instructions.)

1.9.12 Apollo Soteria UL Switch Monitor Input/Output Module (SA4705-703)

(Refer to Apollo Fire Detectors Limited's part number SA4705-703 installation manual for installation instructions.)

1.9.13 Apollo Soteria UL NAC Module (SA4705-706)

(Refer to Apollo Fire Detectors Limited's part number SA4705-706 installation manual for installation instructions.)

1.9.14 Apollo XP95A Input/Output Module – 120Vac (55000-859)

(Refer to Apollo Fire Detectors Limited's part number 55000-859 installation manual for installation instructions.)

1.9.15 FCI Monitor Module (AMM-4)

(Refer to Fire Controls Instruments' part number AMM-4 installation manual for installation instructions.)

1.9.16 FCI Mini Monitor Module (AMM-2)

(Refer to Fire Controls Instruments' part number AMM-2 installation manual for installation instructions.)

1.9.17 FCI Control Module (AOM-2S)

(Refer to Fire Controls Instruments' part number AOM-2S installation manual for installation instructions.)

1.9.18 FCI Relay Control Module (AOM-2R)

(Refer to Fire Controls Instruments' part number AOM-2R installation manual for installation instructions.)

1.9.19 FCI Zone Monitor Module (AMM-4S)

(Refer to Fire Controls Instruments' part number AMM-4S installation manual for installation instructions.)

1.9.20 Edwards Monitor Module (M500MF)

(Refer to Edwards Systems Technology's part number M500MF installation manual for installation instructions.)

1.9.21 Edwards Mini Monitor Module (M501MF)

(Refer to Edwards Systems Technology's part number M501MF installation manual for installation instructions.)

1.9.22 Edwards Relay Control Module (M500RF)

(Refer to Edwards Systems Technology's part number M500RF installation manual for installation instructions.)

1.9.23 Edwards Control Module (M500SF)

(Refer to Edwards Systems Technology's part number M500SF installation manual for installation instructions.)

1.9.24 Notifier Monitor Module (FMM-1)

(Refer to Notifier's part number FMM-1 installation manual for installation instructions.)

1.9.25 Notifier Mini Monitor Module (FMM-101)

(Refer to Notifier's part number FMM-101 installation manual for installation instructions.)

1.9.26 Notifier Relay Control Module (FRM-1)

(Refer to Notifier's part number FRM-1 installation manual for installation instructions.)

1.9.27 Notifier Control Module (FCM-1)

(Refer to Notifier's part number FCM-1 installation manual for installation instructions.)

1.9.28 Notifier Zone Monitor Module (FZM-1)

(Refer to Notifier's part number FZM-1 installation manual for installation instructions.)

1.9.29 Fire-Lite Monitor Module (MMF-300 (old part # M300))

(Refer to Fire-Lite Alarms' part number MMF-300 installation manual for installation instructions.)

1.9.30 Fire-Lite Mini Monitor Module (MMF-301 (old part # M301))

(Refer to Fire-Lite Alarms' part number MMF-301 installation manual for installation instructions.)

1.9.31 Fire-Lite Relay Control Module (CRF-300 (old part #C304))

(Refer to Fire-Lite Alarms' part number CRF-300 installation manual for installation instructions.)

1.9.32 Fire-Lite Control Module (CMF-300 (old part #C304))

(Refer to Fire-Lite Alarms' part number CMF-300 installation manual for installation instructions.)

1.9.33 Fire-Lite Zone Monitor Module (MMF-302)

(Refer to Fire-Lite Alarms' part number MMF-302 installation manual for installation instructions.)

1.9.34 Honeywell Monitor Module (TC809A1058)

(Refer to Honeywell's part number TC809A1058 installation manual for installation instructions.)

1.9.35 Honeywell Relay Control Module (TC810R1024)

(Refer to Honeywell's part number TC810R1024 installation manual for installation instructions.)

1.9.36 Honeywell Control Module (TC810N1013)

(Refer to Honeywell's part number TC810N1013 installation manual for installation instructions.)

1.10 Accessories

1.10.1 Computrols SC1

The Computrols SC1 (Refer to Computrols, Inc.'s part number SC1 installation manual for installation instructions.)

1.10.2 Precon Encapsulated Thermistor Sensor

The Precon Encapsulated Thermistor Sensors are type III 10K ohm thermistors providing precision remote temperature sensing. The active sensing element is a highly stable precision thermistor material accurate to within $\pm 0.36^{\circ}\text{F}$ ($\pm 0.2^{\circ}\text{C}$). They come factory installed. (Refer to Precon's part number ST-R3 installation manual for further information.)

Section 2.0 »

Database Setup Using CBAS

2.1 Commissioning Hardware Diagram

STEP 1

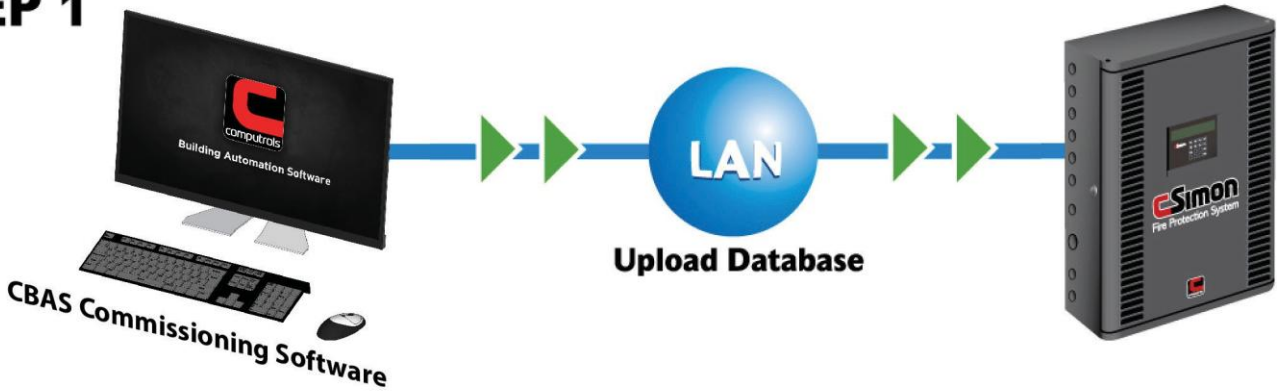

STEP 2

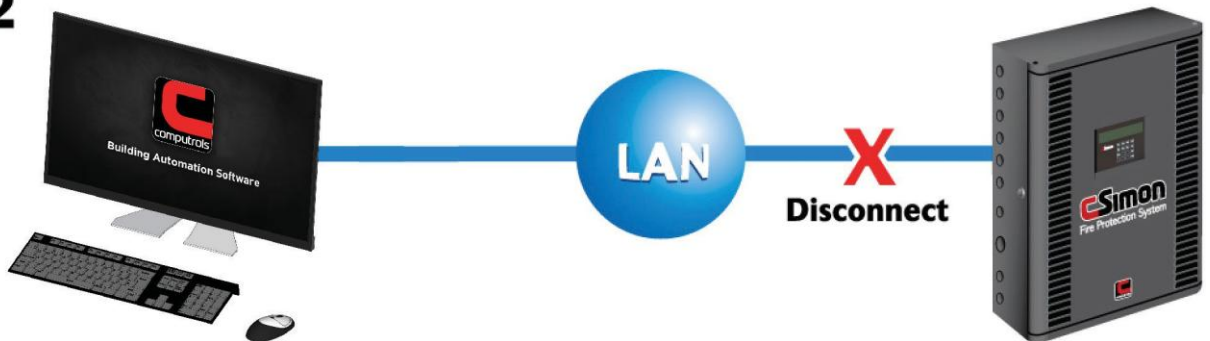

2.2 Software Setup

Once a CSimon Fire System is commissioned, the software is for monitoring only. Alarms must be acknowledged from the user interface panel. The entire system must be programmed from the monitoring computer. To do this, the panel being programmed must be placed into Commission Mode. If a Fire Panel does not have a database, it will automatically go into Commission Mode after 3 minutes. When entering Real mode in the software, the database will download to the panel automatically, as long as it doesn't have a database already. To replace or update a database, erase the database on the panel first from the software. To do this, click on the controller in Hardware View and click Erase Database. The new database will then download to the panel.

2.2.1 Create New Database

Open the CSimon software by clicking on CSimon on the Program Menu or the Icon on the Windows Desktop. If the software opens to an existing database, you will need to close it by going to the System Menu and clicking on Close Database. Once the database is closed, you will only see 2 menus listed: Database and System.

To start a new database, Click on Database, then New Database, and you will see the following window.

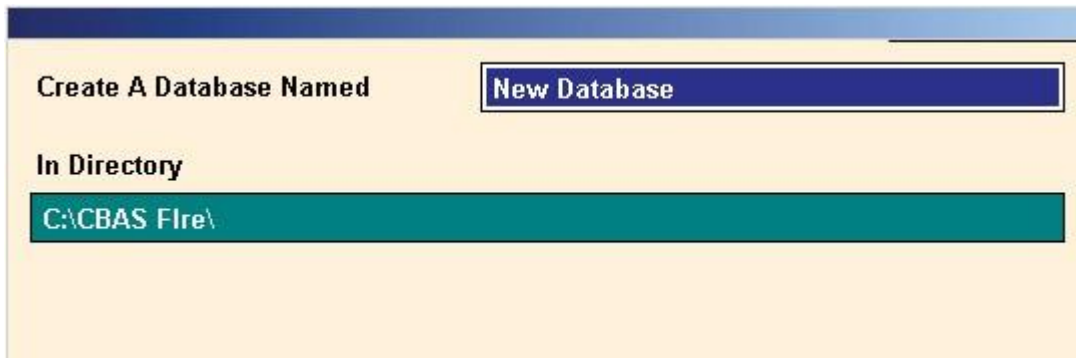

Enter a descriptive name for the database, probably containing the building name. Choose C:\CBAS for the location. Click "Create Database Now!" and a folder will be created. After a short time, the database will open to Hardware View, showing 2 channels.

Channels in Building X Alarm System						
Channel Name	Channel Type	Bytes/Sec	Scan Rate	Controllers		
				Online	Offline	Off Scan
Workstation Channel	TCP/IP for Workstations	---	---	1	0	---
Controller Channel	TCP/IP for Controllers	---	---	0	0	0
Add A Channel						

Click on the Controller Channel and click Program. Notice the Local IP Address in the Channel Program Screen. This is the IP address of the Network Interface Card on the computer, which has been entered automatically by the software. If the IP address of the computer ever changes, you need to come here to change it also. Now press Escape or right-click to close the Channel Program Screen.

2.2.2 Adding Panels

Click on the Controller Channel again and select Controllers.

Click “Add a BASNet Controller” and you will see the following window.



The screenshot shows a configuration window titled "Add A Controller named". The name field is set to "Building X Master". Below this, it says "To Controller Channel". The "Configured as" dropdown is set to "FIRE". The "at Address" field is set to "192.168.1.3 STATIC IP". There are three radio button options: "CREATE A NEW BLANK DATABASE" (selected), "USE A TEMPLATE TO CREATE THE NEW CONTROLLER'S DATABASE", and "COPY A DATABASE FROM ANOTHER CONTROLLER". At the bottom is a large green button labeled "Add Controller NOW!".

This first panel will be the Master Panel, so give it a descriptive name containing the word “Master.”

Under “Configured As”, choose Fire.

Under “at Address”, give the panel an IP address that is not already being used. The software defaults to 192.168.1.199, which is the default for panels chipped from the factory. As more panels are added, this number will increment.

Click “Add Controller NOW!” and after a short time, the following configuration window will appear.

Fire Panel Setup

- This will be the ONLY FIRE controller.
- This will be the MASTER FIRE Controller on a multi FIRE controller 485 network.
- It will use Class A 485 communications between all other FIRE controllers.
 - It will use Class B 485 communications between all other FIRE controllers.
 - The Secondary 485 port will NOT be used.
 - The Secondary 485 port will be used to communicate with SC1 controllers.
- This will NOT be the master FIRE Controller on a multi FIRE controller network.
- I Don't Know the answer!!!

Point Name Prefix	Module Type
AB FLR 1 E	Apollo Class B
AB FLR 1 W	Apollo Class B
AB FLR 2	Apollo Class B
SSA FLR 3 E	System Sensors Class A
SSA FLR 3 W	System Sensors Class A
M PS1	Power Supply 1
M PS2	Power Supply 2
M BB	Battery Backup
M UI	User Interface

The default for the first panel added is a Master Fire Controller with Class B communications. If you choose Class A, you will not have the choice of using the Secondary 485 port. If you select "I don't know the answer!!!" you will be returned to the controller channel.

In this window, you can add prefixes to the names of the loop modules (LM1-5), power supplies, battery backups and user interface, so they will be easier to identify in the database. Prefixes should probably include the location of the loop and probably the module type. If you don't add prefixes and you add more panels later, you will have naming conflicts and the software will add a ~1 suffix to the names automatically.

Notice the Point Name Prefixes. AB FLR 1 E corresponds to Apollo Class B Floor 1 East.

Under Module Type, choose between Apollo Class A, Apollo Class B, and System Sensor Class A. Power Supply, Battery Backup, and User Interface are hard coded in the panel and cannot be changed. However, you should add a suffix.

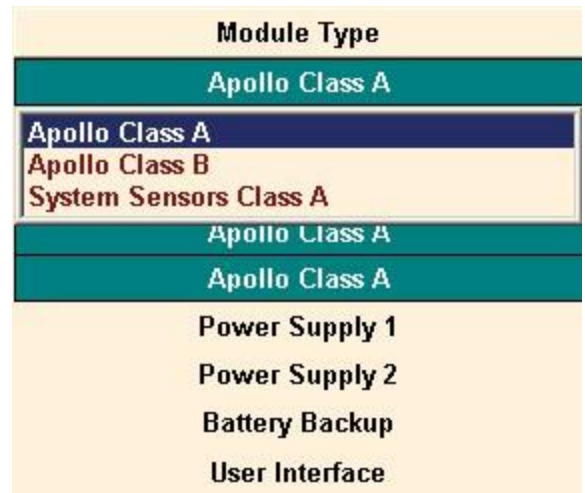

Once you have made all of your choices on this window, Escape or right-click and the panel will be added. This process could take a few minutes.

2.2.3 Adding a Slave Panel

Follow the same procedure to add a second panel and you will get the following Panel Setup window.

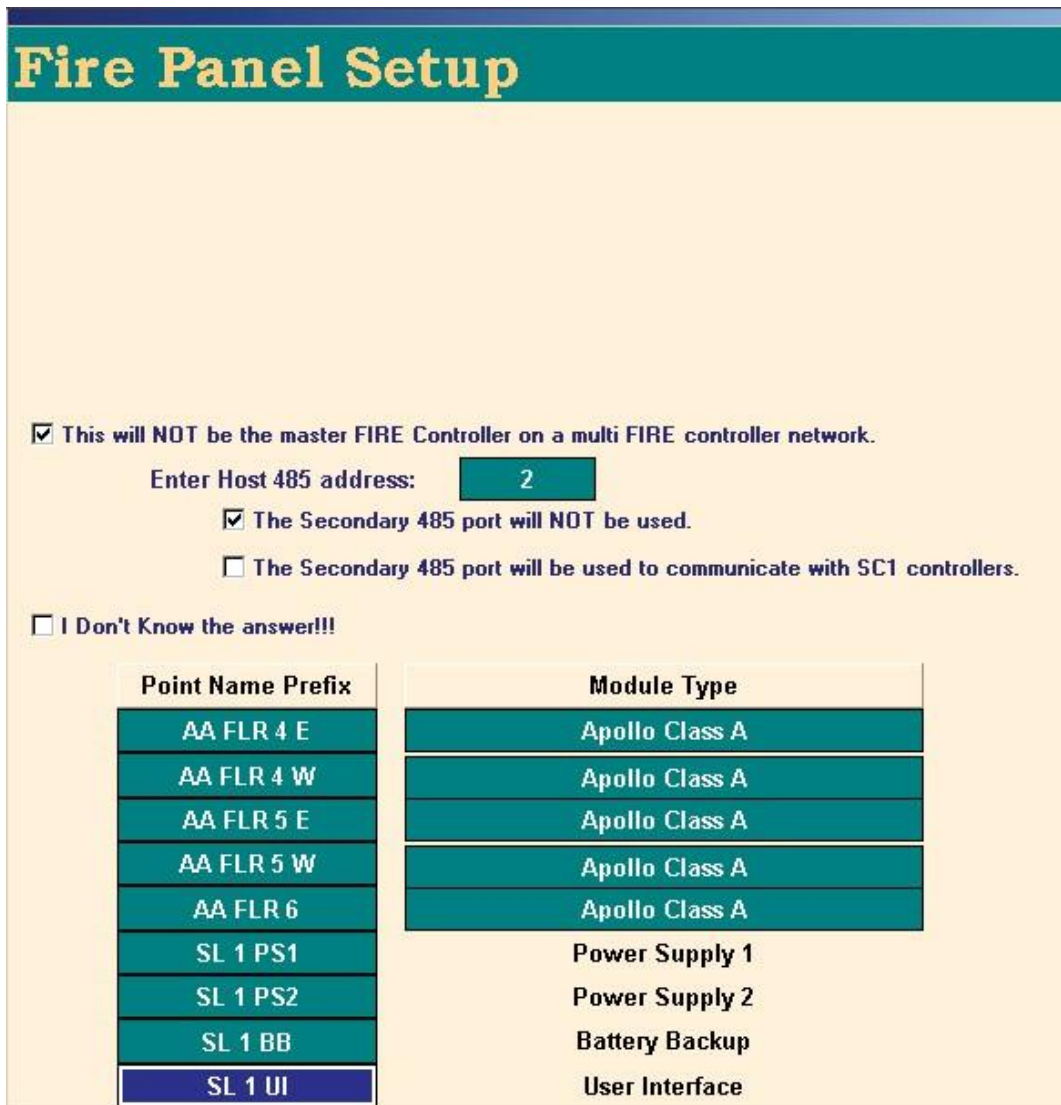

You will not be given the choice of adding a Master Fire Panel this time, because one has already been added.

The Host 485 address is 2, because the Master panel is given address 1 by default and the address is incremented each time a panel is added. This address can later be changed by selecting the panel in Hardware View and going to Channels. From there, select the RS 485 Host channel and go to Program.

Note: The addresses for the master (1) and slave (2-50) 485 controllers have nothing to do with the red knobs on the 8X controller in the panel. The red knobs on the brain have no function on the fire system. If using Class A 485, which loops back to the panel, then the Secondary 485 MUST be address 51 on the Master and the Host 485 on the Master must be 1. This is done automatically when adding a panel, and should not be changed.

2.2.4 Viewing Points

You will now see the two newly-added panels listed in Hardware View.

Computrols' Building Automation System (Editor Mode)					
Text View	Hardware View	Graphics View	Database	System	Reports
Channels in Fire Test DB 3					
Controllers on Controller Channel					
Address	Controller Type	Controller Location		Communication Status	
192.168.1.3 IP	FIRE	Building X Master		Normal	
192.168.1.4 IP	FIRE	Building X Slave 1		Normal	
Add a BASNet Controller					

Click on the Master panel and click points. You will see a list of points that were automatically created when the panel was added. Notice that the name of the panel was added to the point names.

Points in Building X Master				
Position	Point Name	Configuration	Status	
Alarm Output	Building X M Alarm Output	Binary Output	STOP	
Trouble Output	Building X M Trouble Output	Binary Output	STOP	
F. Dept and Cen. St.	Building X M F. Dept and Cen. S	Binary Output	STOP	
B0 Spare1	Building X M B0 Spare1	Binary Output	STOP	
B0 Spare2	Building X M B0 Spare2	Binary Output	STOP	
B0 Spare3	Building X M B0 Spare3	Binary Output	STOP	
Cabinet Temp	Building X M Cabinet Temp	Deg F (10K) Input	0.0 DEG F	
Battery Temp	Building X M Battery Temp	Deg F (10K) Input	0.0 DEG F	
Alarm	Building X M Alarm	Binary Input	NORMAL	
Supervisory	Building X M Supervisory	Binary Input	NORMAL	
Trouble	Building X M Trouble	Binary Input	NORMAL	
Ground Fault	Building X M Ground Fault	Binary Input	NORMAL	
Battery Status	Building X M Battery Status	Supervised Input	NORMAL	
Remote Alarm	Building X M Remote Alarm	Binary Input	NORMAL	
Remote Supervisory	Building X M Remote Supervisory	Binary Input	NORMAL	
Remote Trouble	Building X M Remote Trouble	Binary Input	NORMAL	
Reset	Building X M Reset	Binary Output		
Silence	Building X M Silence	Binary Output		
Acknowledge	Building X M Acknowledge	Binary Output		
Schedule 1	Building X M Schedule 1	Binary Output	DAY	
Schedule 2	Building X M Schedule 2	Binary Output	DAY	
Schedule 3	Building X M Schedule 3	Binary Output	DAY	
Schedule 4	Building X M Schedule 4	Binary Output	DAY	
Schedule 5	Building X M Schedule 5	Binary Output	DAY	
Schedule 6	Building X M Schedule 6	Binary Output	DAY	
Schedule 7	Building X M Schedule 7	Binary Output	DAY	
Add A Software Point				

2.2.5 Adding Detectors and Modules

Click on the Master panel and click Channels.

Channels in Fire Test DB 3		
Controllers on Controller Channel		
Channels in Building X Master		
Port	Channel Name	Channel Type
RS-485 Host	FIRE Channel	FIRENet
RS-485 Secondary	Add A Channel	
Hand Held	Backplane	Backplane
10Meg TCP/IP	Programming Channel	TCP/IP for Controllers
RS-232	Printer Channel	Printer

Click on Backplane, then Controllers, and you will see a list of Loop Modules.

Controllers on Building X Master		
Address	Controller Type	Controller Location
1	Apollo Discovery ClassA	LM1
2	Apollo Discovery ClassA	LM2
3	Apollo Discovery ClassA	LM3
4	Apollo Discovery ClassA	LM4
5	Apollo Discovery ClassA	LM5
6	Power Supply	PS1
7	Power Supply	PS2
8	Battery Backup	BB
9	User Interface	UI

Click on LM1 and choose Points. You will see a list of points on that module.

Points in LM1				
Position	Point Name	Configuration	Status	
Alarm	LM1 Alarm	Binary Input		
Trouble	LM1 Trouble	Binary Input		
Software Discnct	LM1 Software Discnct	Binary Output		
Hardware Discnct	LM1 Hardware Discnct	Binary Input		
Short Circuit	LM1 Short Circuit	Binary Input		
Ground Fault	LM1 Ground Fault	Binary Input		
Voltage A	LM1 Voltage A	Voltage Input	0.00 VOLTS	
Voltage B	LM1 Voltage B	Voltage Input	0.00 VOLTS	
Current A	LM1 Current A	Voltage Input	0.00 AMPS	
Current B	LM1 Current B	Voltage Input	0.00 AMPS	
Errors A	LM1 Errors A	Counter Input	0 ERRORS	
Errors B	LM1 Errors B	Counter Input	0 ERRORS	
A Detector 1	Add A Point			
A Detector 2	Add A Point			
A Detector 3	Add A Point			
A Detector 4	Add A Point			
A Detector 5	Add A Point			
A Detector 6	Add A Point			
A Detector 7	Add A Point			
A Detector 8	Add A Point			
A Detector 9	Add A Point			

The first 12 points are added by default and cannot be removed. Scroll down the list and you will see that you can add up to 100 detectors at addresses 1 through 100. You can also add 26 more detectors or modules (output or monitor) on addresses 101 through 126.

Click “Add a Point” on Detector 1 and the Add Point window appears. Give the point a name and select a configuration from the drop down list. Click “Add Point Now!” and the point is added to the list. It is also added to the bottom of the point list in Text View.

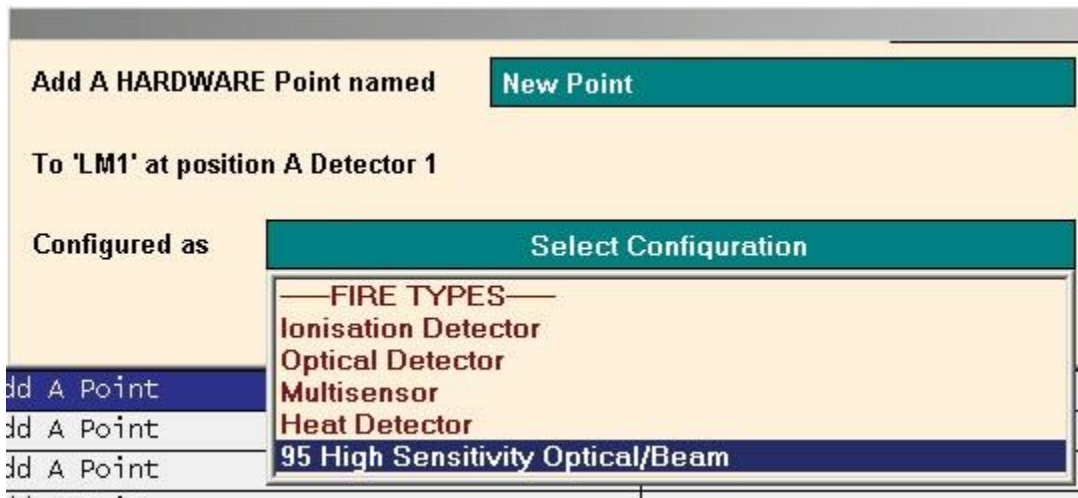

Click “Add a Point” on Detector/Module 101 and the Add Point window appears. Give the point a name and select a configuration from the drop down list. This list contains the same detectors, plus the available modules. Click “Add Point Now!” and the point is added to the list.

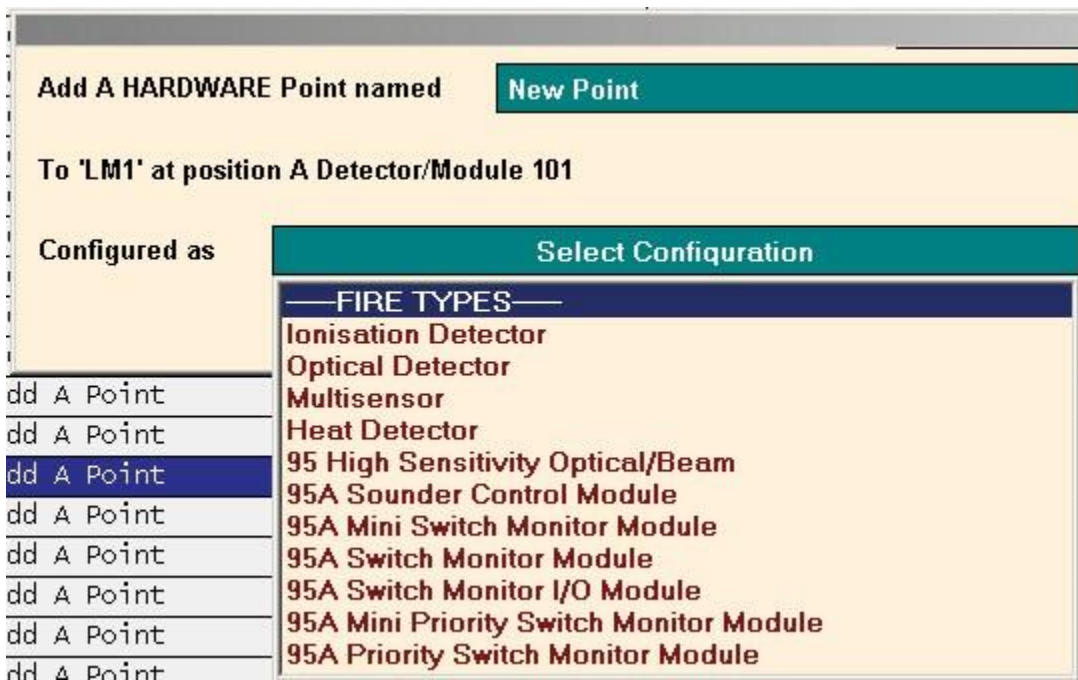

2.2.6 Commanding and Programming Points

Click on one of the points added then click the Command State button.

LM1 ION 1 UNKNOWN DIS			
Command State	Auto	Program	Note Pad
Clear			
LED ON			
Disable Device			
Self Test			
	Ionisation Detector		DISABLED

From here you can change the operating state of the device. However, to change the Command State, the controller must be in Commission Mode, which can only be done through the User Interface. Auto removes the Priority from the point's status and allows the point's state to be commanded by logic or schedule. Click on Program and you will see the Point Program Screen.

Point Program Screen

LM1 ION 1

UNKNOWN DIS by Operator Command

Start Saving History

Show Point Relations

Create Note Pad

Text View Point Positioning

Text View Display Options

Fire

Status

Command State: LED OFF DISABLED

Mode: none

Value: 0

Device Status: UNKNOWN

Drift Limit:

Ionisation Detector

Position

1

Schedule Number (0=none)

0

APOLLO

GroupType

Alarm

- Detector does NOT Blink
- Has Remote LED

Sensitivity

Day Mode3 0.70 and 5 Sec (Normal)

Night Mode3 0.70 and 5 Sec (Normal)

Group Membership

Output Groups

From here you can do many things. First, you can change the point name by clicking on the point name at the top of the screen.

- » From the row of buttons just below the point name, you can:
- » Set up history saving, change history saving settings, and view history
- » View a list of points that are related by logic
- » Create notes about the point
- » Change the position of the point in Text View
- » Add bold text to the point name in Text View

When in Real Mode, you can view the status from here. Below the Status you can:

- » Change the detector or module type
- » Change it's position (address)
- » Change the schedule number (Each panel has up to 7 schedules)
- » Change the Day and Night sensitivity, which works based on the schedule
- » Stop the detector from blinking
- » Enable a Remote LED

Note: You cannot change Manufacturers on an Apollo loop module. Also, the group type cannot be changed because all detectors are members of the Alarm Group by default. Points can be added to other groups and they will appear here. The procedure for adding and modifying groups will be discussed next.

2.2.7 Groups and Group Membership

Adding points to groups allows you to group points together for the purpose of segregating sections of a building so that the alarms only apply to that section. From the System Menu, click on FIRE and you will see 3 choices:

- » Program Fire Groups
- » Program Fire Points
- » Import Fire Points

2.2.8 Program Fire Groups

Click “Program Fire Groups” to get the Fire Group Editor.

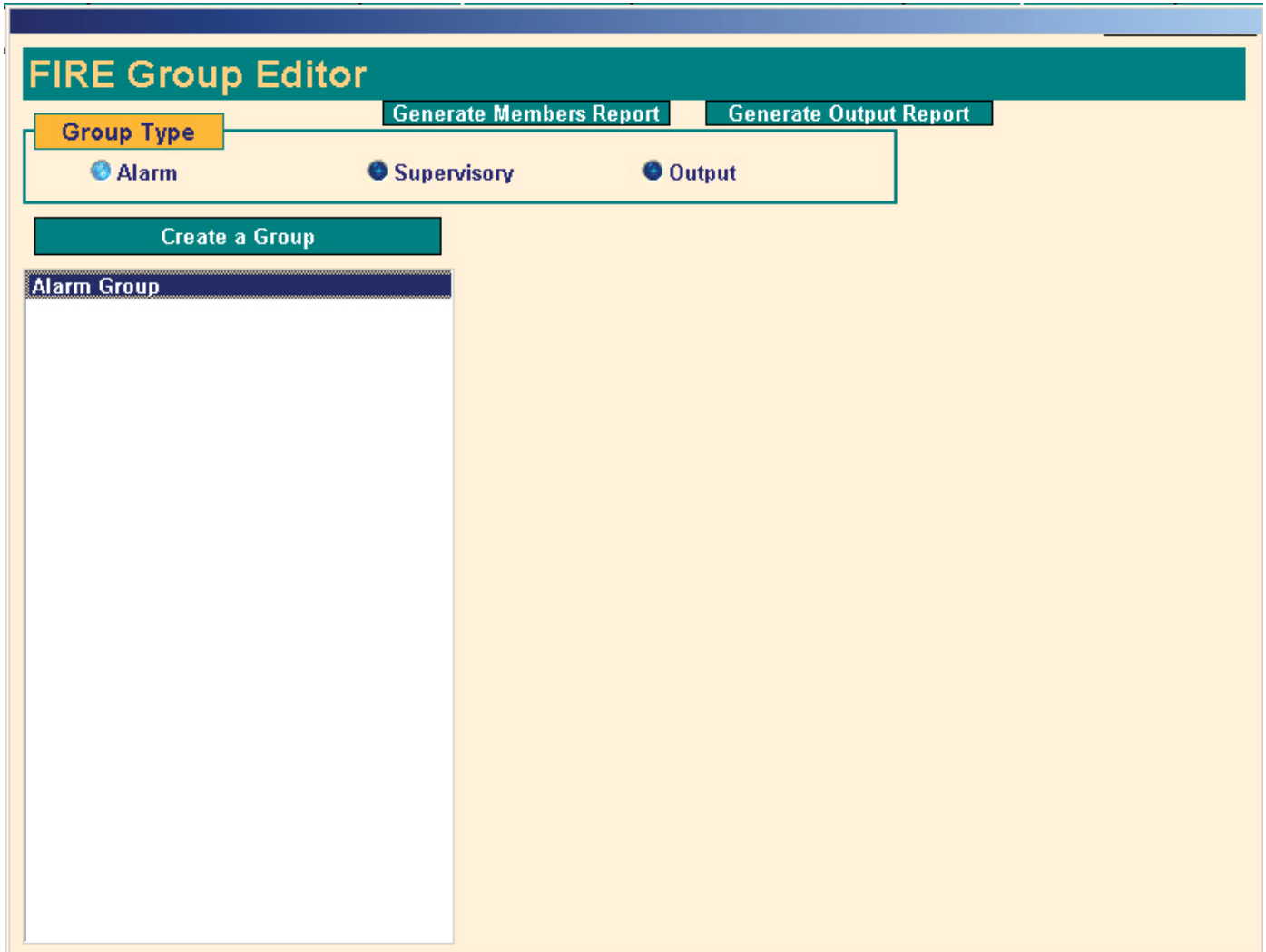

To view existing groups, first select a Group Type from the 3 choices and you will see a list of groups on the left side list.

To create a new group, click “Create a Group” and give the group a name in the window that pops up. Click or press Enter and the group (of Group Type selected above) will be added to the list.

Highlight a group on the list and you will see a list of members belonging to that group. To add members to that group, click “Select Group Members” above the list and select members from the list of eligible members. Once you have selected members, right-click or escape twice to return to the Group Editor.

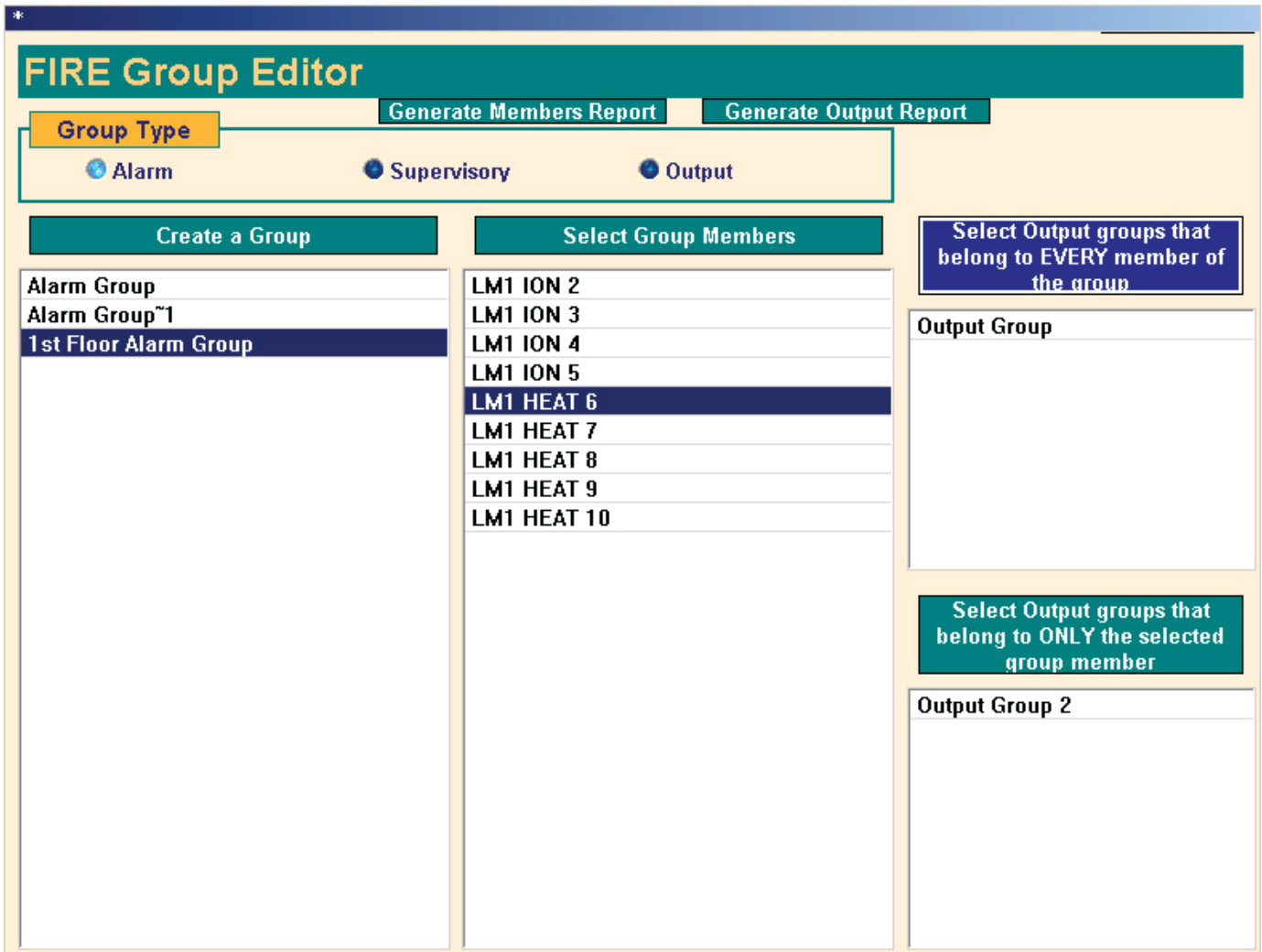

On the right side you can view or add Output Groups that apply to all members of an Alarm Group or individual members.

By choosing the appropriate button at the top of the window, you can generate a printable Members Report or Output Report.

2.2.9 Program Fire Points

From the System Menu, click on Fire, then Program Fire Points. This screen provides another way of managing group membership.

Choose a Group Type and you will see a list of points. Highlight a point and you will see Group Membership and Outlook Groups for that point as well as Day and Night Sensitivity. Everything can be changed from this screen.

- » To add a group, click on an empty line and choose a group from the list.
- » To remove a group, click on the group and select the blank line at the top of the list.
- » To change a point's sensitivity, click on the Day or Night sensitivity and select the new mode from the list.

With Alarm Group Type points, you have the choices shown below, which include Alarm Groups and Output Groups.

With Supervisory Type points, you only see Supervisory Groups.

With Output Type points, you only see Output Groups. However, if you select a Sounder point, you will also be able to view or change a Sounder Group Address.

Right-click or escape to exit the Points Editor

2.2.10 Import Fire Points

Using Apollo FIRE devices and the Apollo Discovery SimSystem software, you can locate all of the devices on your system automatically. Once the devices have been discovered, you save them to an .asy file and they can then be imported.

From the System Menu, select FIRE, then Import Fire Points. Answer Yes to the question then, browse to the location of the .asy file. You will be prompted to select the controller Loop Module to add the points to.

2.2.11 Adding a Computrols SC1 to the System

The SC1 controller will give you an additional 25 supervised points and is wired to the Secondary 485 Port on the 8X in a Slave Fire panel only. The points can be configured as up to 25 input points, or up to 16 output points and 9 input points.

To add a SC1:

- » Go to Hardware View then click the Controller Channel and click Controllers.
- » Click on a slave controller then Channels.
- » Click Add a Controller on the RS-485 Secondary channel.
- » Give the channel a descriptive name
- » Select Opto-22 on Controller for the Channel Type
- » Click Add Channel Now!
- » Click the newly added channel and click Controllers
- » On the line for the address you want to use, click Add a Controller
- » Give the Controller a descriptive name
- » Choose SC1 for “Configured as”
- » Click Add Controller Now!

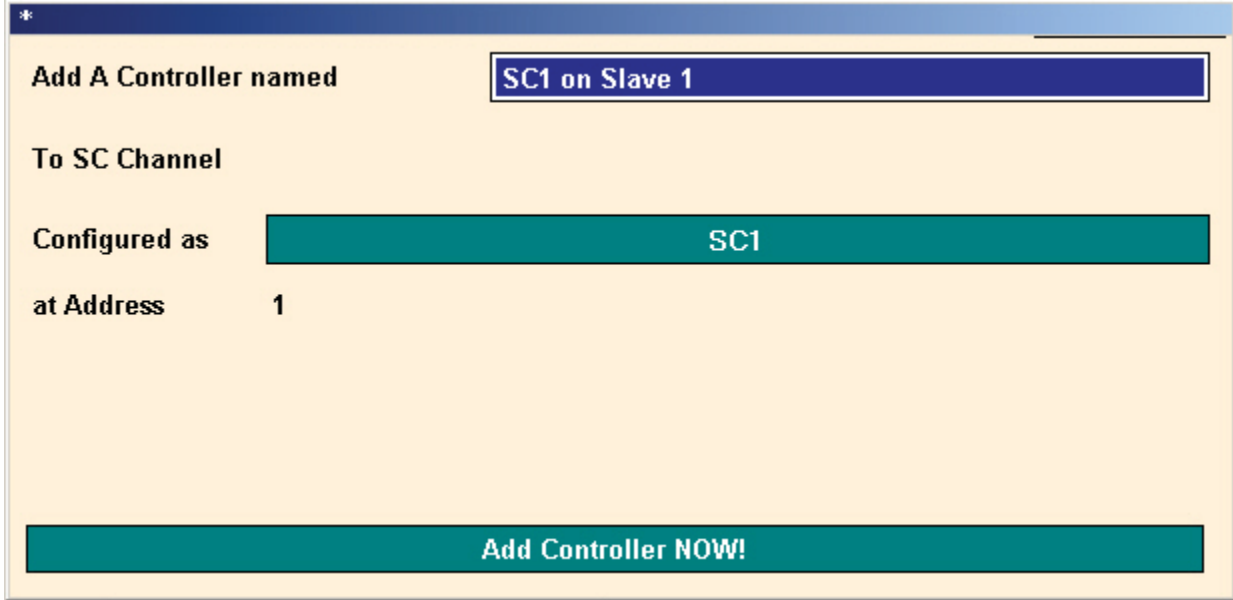

The screenshot shows a dialog box titled "Add A Controller named" with a text input field containing "SC1 on Slave 1". Below this, the label "To SC Channel" is present. The "Configured as" field is a dropdown menu set to "SC1". The "at Address" field is set to "1". At the bottom of the dialog is a large green button labeled "Add Controller NOW!".

Now that the controller is added to the list, click on the controller and click Points. To add points:

- » Click “Add A Point”
- » Give the point a descriptive name
- » Choose a configuration from the drop-down list. (NO) means Normally Open

» Click Add Point Now!

Now that the point is added to the list, click on the point and you will see the Point Program screen. Shown below is the Point Program screen for a Supervised Point.

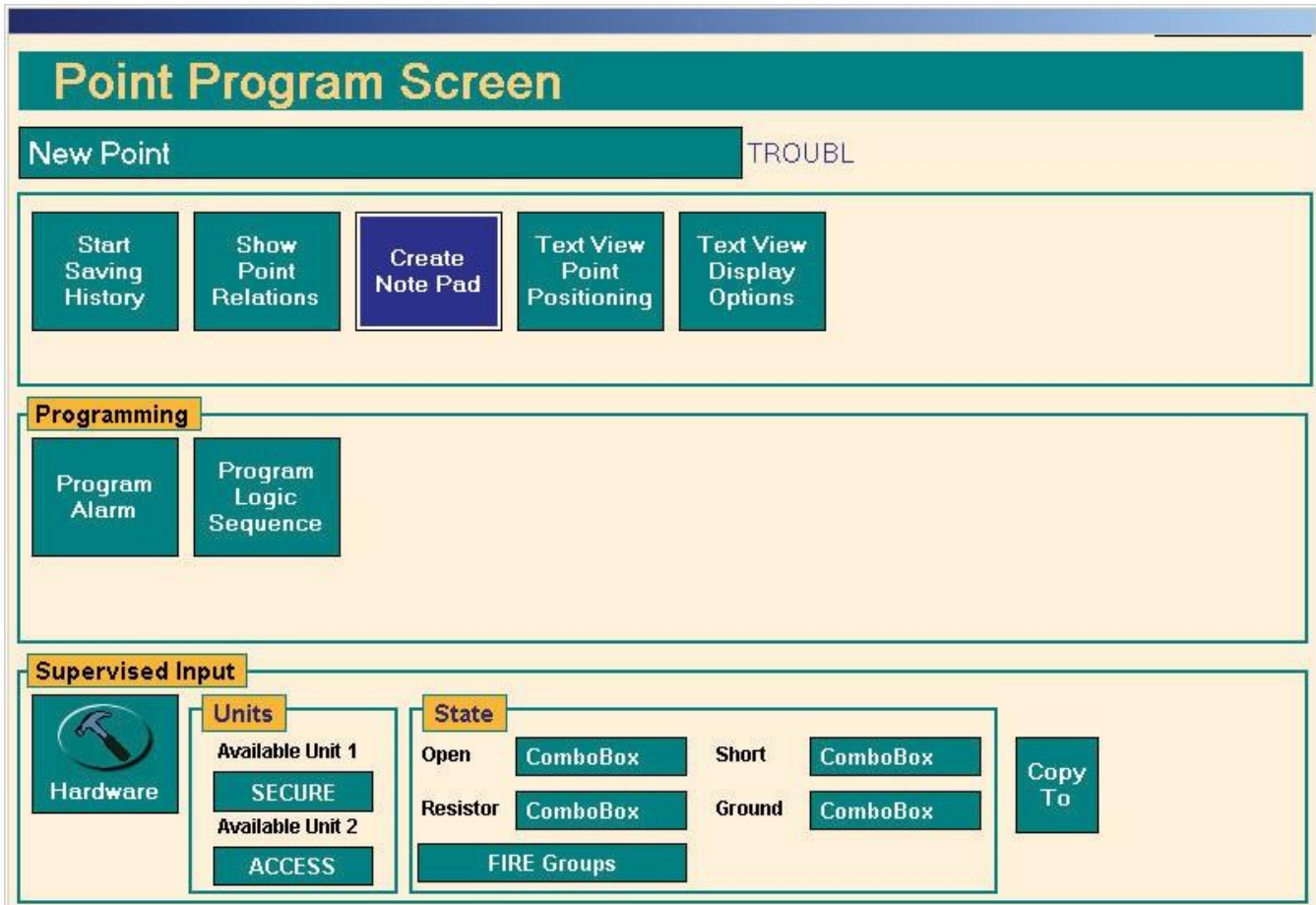

Under Units, click on the “Available Unit 1” button and you will see a list of unit names for you to choose from. You can also add your own unit names. Available Unit 1 will show as the status of the point when it is open. When it is closed, it will show Unit 2.

The State box shows the states of the supervised input: Open, Short, Resistor, or Ground.

From the Fire Groups button, you can select the groups that will be put into alarm if the supervised input goes into Alarm.

2.3 Remote Panels

If someone requires that the Alarm, Trouble, Fire Dept relay goes on for both a local and/or remote items than a Factory Certified Logic Writer will have to write logic. The logic would need to be by priority Logic4 below.

If Alarm Software Point is ALARM

AND RunMinutes > 10

AND Fire Dept Relay is STOP
then RESET the FIRE panel
else if Alarm Software Point is ALARM
then START Fire Dept Relay
else STOP Fire Dept Relay

This would cause the FIRE panel to reboot if an ALARM occurred. The ALARM would have to come in again within 10 minutes of the panel rebooting for the Fire Dept Relays to change state.

Section 3.0 »

User Interface Operation

3.1 Keypad Operations

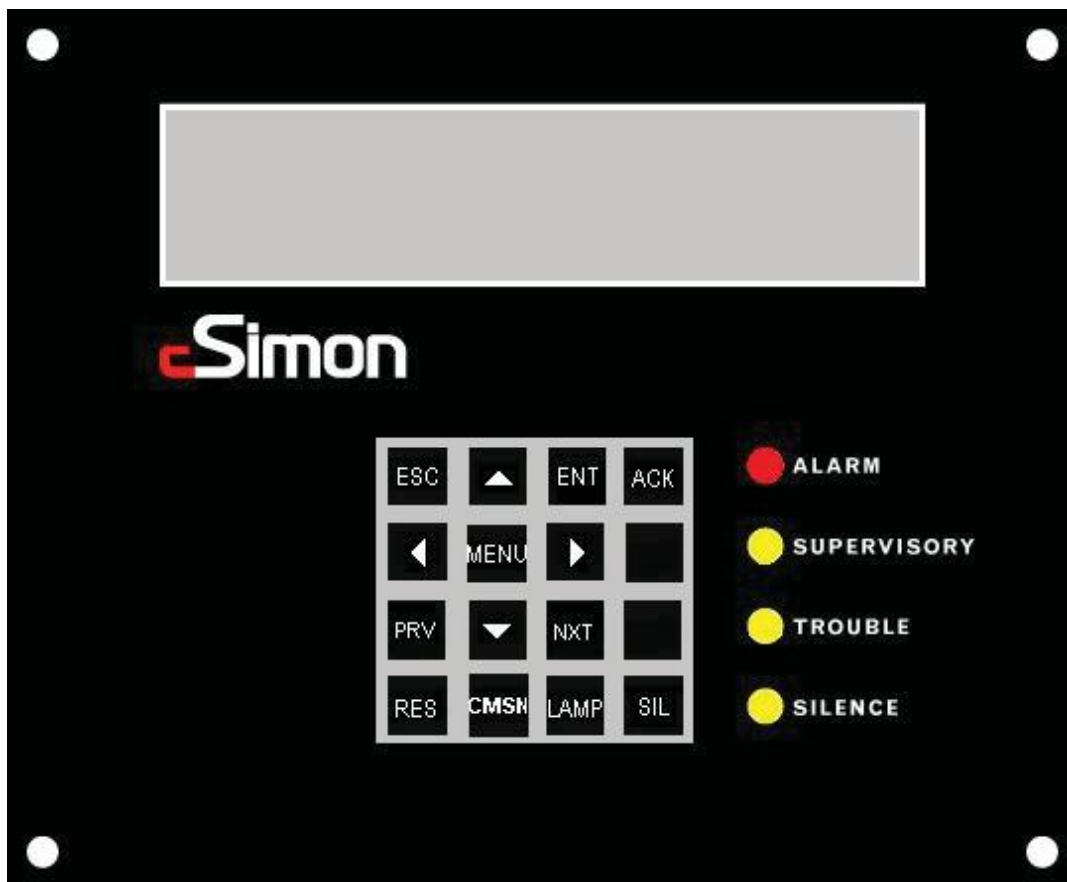

The normal screen will display:

CSimon Fire System

COMPUTROLS INC.

Revision 1.0

hh:mm:ss Day Month Year

If the time is changing on the user interface than the user interface is communicating with the Master Fire brain.

When the user presses the MENU button they will see:

Enter Passcode: 0000

See Section 3.2 for passcode information.

The user will use the Left, Right, Up and Down arrows to enter the number. Pressing Escape exits and pressing Enter accepts the number. The first screen will look like:

**> Point – Operates on a single point

Group – Starts an entire group

Walk Test

System

Exit

Pressing the up/down arrow keys will move the **>. Pressing the Enter or Right Arrow key will select the menu option.

3.1.1 Point

Selecting Point will give the next screen:

**> Select Point By Alarm Group

Select Point By Supervisory Group

Select Point By Output Group

Select Point By Module

3.1.1.1 Select Point By Alarm Group

All of the Alarm Groups will be displayed. Select an Alarm Group and all of the points in that Alarm Group will be displayed. Use Prev and Next to scroll through the list of points.

3.1.1.2 Select Point By Supervisory Group

All of the Supervisory Groups will be displayed. Select a Supervisory Group and all of the points in that Supervisory Group will be displayed.

3.1.1.3 Select Point By Output Group

All of the Output Groups will be displayed. Select an Output Group and all of the points in that Output Group will be displayed.

3.1.1.4 Select Point By Module

All of the module cards will be displayed. Starting with the 5 Loop boards and continuing through the Power Supply, Battery Backup and User Interface. Selecting a Module will display all of the points in that module.

After a point has been selected a point screen will appear. This will be different according to the type of point that was selected. From here a point may be commanded. The valid commands from the list below will be displayed according to the point type:

- » Disable Device / Enable Device
- » Start Self Test
- » Start Rapid Compensation
- » Turn LED ON / Turn LED OFF
- » Turn Device ON / Turn Device OFF

For an Apollo Discovery device the Manufacture Date and Drift value will also be displayed in the point screen.

3.1.2 Group

A list of all groups will be displayed. Selecting a Group will turn it on. To turn off a group you must RESET the FIRE panel.

3.1.3 Walk Test

Walk Test will display the next screen:

- **> SLC 1 – Start Walk Test
- SLC 2 - Start Walk Test
- SLC 3 - Start Walk Test
- SLC 4 - Start Walk Test
- SLC 5 - Start Walk Test

Selecting a SLC module will put the entire module into Walk Test mode. Any device that goes into Alarm on that module will display a Walk Test Alarm but NO end devices will actually be set off. A walk test will timeout after 6 hours.

If a SLC is already in walk test then the menu will display “STOP Walk Test xxx Min Remain”. Where xxx is the time remaining before the Walk Test will be stopped.

3.1.4 System

System will be followed by the following screen:

**> Date Time

Module Information

Passcode Editor

TCP / IP Setup

3.1.4.1 Date Time

Date Time will display the current date and time and allow the user to change the date and time.

3.1.4.2 Module Information

Module Information will display the part number, version number and other information about the module. Use Prev / Next to scroll through all of the modules installed in the Fire panel.

3.1.4.3 Passcode Editor

Passcode Editor will allow the user to change the passcodes for each level.

3.1.4.4 TCP/IP Setup

TCP / IP Setup will allow the user to change the IP address and the subnet of the FIRE panel.

3.2 Passcodes

There are 3 levels of Passcode. Each has a valid range from 0000 to 9999. The Level 3 Passcode is required to do the following:

Edit Passcodes.

Put the system in Walk Test

Edit Date Time

Edit TCP/IP address and SubNet Mask

Command Points

Turn on a Group

There is also a separate passcode to put the system into or take it out of Commission mode.

The default Passcodes are:

Level 1 - 0001

Level 2 - 0002

Level 3 - 0003

Commission - 0007

If a menu is displayed and there is no button press for 5 minutes the user interface will timeout and go back to the opening screen.

If an incorrect passcode is entered 5 times in a row the menu feature will be locked out for a period of 5

minutes.

If there is no 485 communication between the User Interface and the Brain Module for a period of 1 minute the user interface will display:

DPU FAILURE...

And the User Interface buzzer will sound continuously and the Trouble LED will light up.

3.2.1 Acknowledge

When an Alarm is displayed on the User interface the internal buzzer will sound continuously. If a Supervisory is displayed the buzzer will be on for 5 seconds and then off for 1 second. For a Trouble the Buzzer will be on for 3 seconds and then off for 1 second. For a Return to Normal condition the buzzer will sound 1 second on and 1 second off. Once the displayed condition has been acknowledged the buzzer will stop sounding.

Alarms are displayed and therefore acknowledged one at a time. But Supervisories, Troubles and Return to Normals are displayed 4 at a time and therefore pressing the acknowledge button acknowledges all 4 displayed items.

3.2.2 Reset

The Reset button may be pressed at ANY time. Once pressed the following will be displayed:

Are you sure you want to RESET?

Press RESET Again to RESET!

Any other key to ABORT.

Pressing Reset again will reset the FIRE controller. It will also reset all other FIRE controllers that are connected via 485.

3.2.3 Silence

Pressing the Silence button will turn off the local piezo buzzer on ALL Fire panels that are interconnected via 485. If another Alarm comes in while silenced the local piezo buzzer will resound. The Silence LED will remain lit after the Silence button has been pressed. A RESET is required to make the Silence LED go off.

3.2.4 Lamp Test

Pressing the Lamp Test button will light up all LEDs and sound the internal User Interface Buzzer for a period of approximately 6 seconds.

3.2.5 Commission Mode

This button is used to enter/exit commission mode. While the FIRE panel is in Commission mode the Trouble LED will remain on. Also, a Trouble will be displayed every hour while in Commission mode. The FIRE panel must be in commission mode before any programming can be done.

Section 4.0 »

Terminal Descriptions/Installation Instructions

4.1 Terminal Description With Installation Instructions

4.1.1 Alarm No/Alarm Common

The ALARM NO and ALARM COMMON terminal is a normally open dry contact. During normal conditions, the contact will remain open. When any part of the fire system is in an alarm condition, the contact will be closed. See chart below for contact ratings.

Load	Resistive load (p.f. = 1)	Inductive load (p.f. = 0.4) (L/R = 7 ms)
Rated load	0.40 A at 125 VAC, 2 A at 30 VDC	0.20 A at 125 VAC, 1 A at 30 VDC
Contact material	Ag (Au clad)	
Carry current	3 A	
Max. operating voltage	250 VAC, 220 VDC	
Max. operating current	3 A (AC), 3 A (DC)	1.50 A (AC), 1.50 A (DC)
Max. switching capacity	50 VA, 60 W	25 VA, 30 W
Min. permissible load	10 μ A, 10 mVDC	

4.1.2 Alarm NC/Alarm Common

The ALARM NC and ALARM COMMON terminal is a normally closed dry contact. During normal conditions, the contact will remain closed. When any part of the fire system is in an alarm condition, the contact will be opened. See chart below for contact ratings.

Load	Resistive load (p.f. = 1)	Inductive load (p.f. = 0.4) (L/R = 7 ms)
Rated load	0.40 A at 125 VAC, 2 A at 30 VDC	0.20 A at 125 VAC, 1 A at 30 VDC
Contact material	Ag (Au clad)	
Carry current	3 A	
Max. operating voltage	250 VAC, 220 VDC	
Max. operating current	3 A (AC), 3 A (DC)	1.50 A (AC), 1.50 A (DC)
Max. switching capacity	50 VA, 60 W	25 VA, 30 W
Min. permissible load	10 μ A, 10 mVDC	

4.1.3 Trouble No/Trouble Common

The TROUBLE NO and TROUBLE COMMON terminal is a normally open dry contact. During normal conditions, the contact will remain open. When any part of the fire system is in a trouble, ground fault (1.0 k-ohms impedance trigger) or supervisory condition, the contact will be closed. When the AC Power goes out the Trouble Relay will not energize for 90 minutes. Unless there is some other kind of trouble in the system. See chart below for contact ratings.

Load	Resistive load (p.f. = 1)	Inductive load (p.f. = 0.4) (L/R = 7 ms)
Rated load	0.40 A at 125 VAC, 2 A at 30 VDC	0.20 A at 125 VAC, 1 A at 30 VDC
Contact material	Ag (Au clad)	
Carry current	3 A	
Max. operating voltage	250 VAC, 220 VDC	
Max. operating current	3 A (AC), 3 A (DC)	1.50 A (AC), 1.50 A (DC)
Max. switching capacity	50 VA, 60 W	25 VA, 30 W
Min. permissible load	10 μ A, 10 mVDC	

4.1.4 Trouble NC/Trouble Common

The TROUBLE NC and TROUBLE COMMON terminal is a normally closed dry contact. During normal conditions, the contact will remain closed. When any part of the fire system is in a trouble, ground fault (1.0 k-ohms impedance trigger) or supervisory condition, the contact will be opened. When the AC Power goes out the Trouble Relay will not energize for 90 minutes. Unless there is some other kind of trouble in the system. See chart below for contact ratings.

Load	Resistive load (p.f. = 1)	Inductive load (p.f. = 0.4) (L/R = 7 ms)
Rated load	0.40 A at 125 VAC, 2 A at 30 VDC	0.20 A at 125 VAC, 1 A at 30 VDC
Contact material	Ag (Au clad)	
Carry current	3 A	
Max. operating voltage	250 VAC, 220 VDC	
Max. operating current	3 A (AC), 3 A (DC)	1.50 A (AC), 1.50 A (DC)
Max. switching capacity	50 VA, 60 W	25 VA, 30 W
Min. permissible load	10 μ A, 10 mVDC	

4.1.5 F Dept No/F Dept Common

The F DEPT NO and F DEPT COMMON terminal is a normally open dry contact. During normal conditions, the contact will remain open. When there is a microprocessor failure, the contact will be closed. This relay is designed for connection to a UL Listed Digital Alarm Communicator Transmitter (DACT). See chart below for contact ratings.

Load	Resistive load (p.f. = 1)	Inductive load (p.f. = 0.4) (L/R = 7 ms)
Rated load	0.40 A at 125 VAC, 2 A at 30 VDC	0.20 A at 125 VAC, 1 A at 30 VDC
Contact material	Ag (Au clad)	
Carry current	3 A	
Max. operating voltage	250 VAC, 220 VDC	
Max. operating current	3 A (AC), 3 A (DC)	1.50 A (AC), 1.50 A (DC)
Max. switching capacity	50 VA, 60 W	25 VA, 30 W
Min. permissible load	10 μ A, 10 mVDC	

4.1.6 F Dept NC/F Dept Common

The F DEPT NC and F DEPT COMMON terminal is a normally closed dry contact. During normal conditions, the contact will remain closed. When there is a microprocessor failure, the contact will be opened. This relay is designed for connection to a UL Listed Digital Alarm Communicator Transmitter (DACT). See chart below for contact ratings.

Load	Resistive load (p.f. = 1)	Inductive load (p.f. = 0.4) (L/R = 7 ms)
Rated load	0.40 A at 125 VAC, 2 A at 30 VDC	0.20 A at 125 VAC, 1 A at 30 VDC
Contact material	Ag (Au clad)	
Carry current	3 A	
Max. operating voltage	250 VAC, 220 VDC	
Max. operating current	3 A (AC), 3 A (DC)	1.50 A (AC), 1.50 A (DC)
Max. switching capacity	50 VA, 60 W	25 VA, 30 W
Min. permissible load	10 μ A, 10 mVDC	

4.1.7 Cen St No/Cen St Common

The CEN ST NO and CEN ST COMMON terminal is a normally open dry contact. During normal conditions, the contact will remain open. When there is an alarm, the contact will be closed. This relay is designed for connection to a UL Listed Digital Alarm Communicator Transmitter (DACT). See chart below for contact ratings.

Load	Resistive load (p.f. = 1)	Inductive load (p.f. = 0.4) (L/R = 7 ms)
Rated load	0.40 A at 125 VAC, 2 A at 30 VDC	0.20 A at 125 VAC, 1 A at 30 VDC
Contact material	Ag (Au clad)	
Carry current	3 A	
Max. operating voltage	250 VAC, 220 VDC	
Max. operating current	3 A (AC), 3 A (DC)	1.50 A (AC), 1.50 A (DC)
Max. switching capacity	50 VA, 60 W	25 VA, 30 W
Min. permissible load	10 μ A, 10 mVDC	

4.1.8 Cen St NC/Cen St Common

The CEN ST NC and CEN ST COMMON terminal is a normally closed dry contact. During normal conditions, the contact will remain closed. When there is an alarm, the contact will be opened. This relay is designed for connection to a UL Listed Digital Alarm Communicator Transmitter (DACT). See chart below for contact ratings.

Load	Resistive load (p.f. = 1)	Inductive load (p.f. = 0.4) (L/R = 7 ms)
Rated load	0.40 A at 125 VAC, 2 A at 30 VDC	0.20 A at 125 VAC, 1 A at 30 VDC
Contact material	Ag (Au clad)	
Carry current	3 A	
Max. operating voltage	250 VAC, 220 VDC	
Max. operating current	3 A (AC), 3 A (DC)	1.50 A (AC), 1.50 A (DC)
Max. switching capacity	50 VA, 60 W	25 VA, 30 W
Min. permissible load	10 μ A, 10 mVDC	

4.1.9 Binary Output/Binary Common

The BINARY OUTPUT and BINARY COMMON terminals are 24 Volt DC outputs. The current output is dependent on the fire system's ambient temperature. See chart below. The trip current is the current level in milliamps when the fire system's resettable fuse will trip.

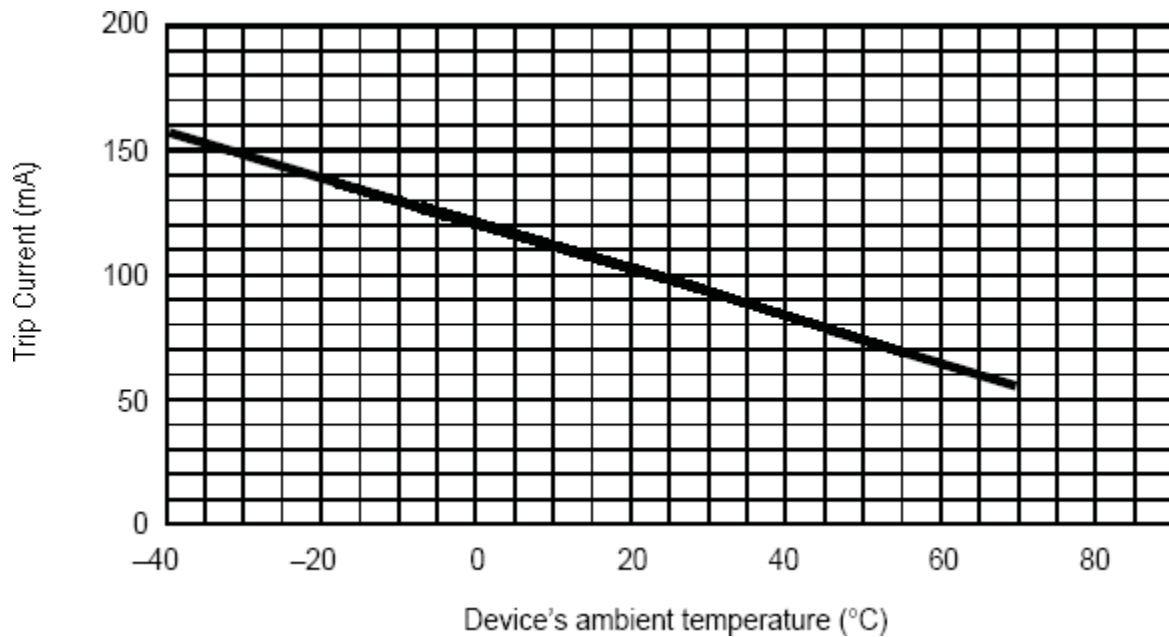

4.1.10 Temp (Cabinet/Battery) (Optional)

The CABINET TEMP and BATTERY TEMP terminals are 10K Type III thermistor inputs. These inputs are used to measure the temperature of the fire system inside of the cabinet and the temperature of the batteries.

4.1.11 Host +, -, Shield

This terminal is used when there are multiple Fire Controllers in one system. It uses RS-485 communication. This terminal is the host port, which is a separate channel from the secondary port.

4.1.12 SECONDARY +, -, SHIELD

This terminal is used when there are multiple Fire Controllers in one system. It uses RS-485 communication. This terminal is the secondary port, which is a separate channel from the host port.

4.1.13 USER INTERFACE

The User Interface terminal connects the User Interface Module to the Terminal Board via a 10 pin ribbon cable. This terminal uses a connector with latching ears which locks the ribbon cable down in normal situations, but allows the User Interface to be replaced. The ribbon cable should never be unplugged unless the Fire Controller is being serviced.

4.1.14 SLC + (A, B)

The SLC + (A, B) terminals are used to connect the Signaling Line Circuit (or loop) devices. The "+" denotes the positive polarity of the SLC device. These signals are Power Limited. SLC Output Voltage: 21.8 to 21.8 Volts DC, Max current = 300mA, Impedance = 16 Ohms. Note that your CSimon can either connect to APOLLO manufacturer devices or FCI, NOTIFIER, HONEY-WELL, FIRELITE and EDWARDS devices, but not both. These devices include the detectors listed in section 1.2.6 and monitor modules listed in section 1.2.7. See section 1.3.1.4 for further explanation.

4.1.15 SLC – (A, B)

The SLC - (A, B) terminals are used to connect the Signaling Line Circuit (or loop) devices. The “-” denotes the negative polarity of the SLC device. These signals are Power Limited. SLC Output Voltage: 21.8 to 21.8 Volts DC. Note that your CSimon can either connect to APOLLO manufacturer devices or FCI, NOTIFIER, HONEYWELL, FIRELITE and EDWARDS devices, but not both. These devices include the detectors listed in section 1.2.6 and monitor modules listed in section 1.2.7. See section 1.3.1.4 for further explanation.

4.1.16 Printer Port (RX, TX, GND, RTS, CTS, GND)

The Printer Port is used to connect the printer listed in section 1.2.2. Connect the signals from the printer to the fire controller according to the signal name. For example, connect RX on the printer to RX on the fire controller. To power the printer, use the 24VDC Regulated Source explained in section 4.1.21.

4.1.17 Local BUS (+, -, S)

The Local Bus terminals will not be used.

4.1.18 Battery +/Battery –

The Battery + terminal is used to connect the positive side of the batteries. The Battery – terminal is used to connect the negative side of the battery

4.1.19 Battery Disconnect Switch

The Battery Disconnect Switch is used to disconnect the battery. This is used for testing the battery. When selecting the switch to the ON position, the batteries are CONNECTED. When selecting the switch to the OFF position, the batteries are DISCONNECTED.

4.1.20 24VAC ~ /

The transformer listed in section 1.2.3 will be pre-wired to these terminals from the factory. The transformer will be connected between the two 24VAC~ terminals and the earth ground will be connected to the.

The ratings are as follows:

- » 120 Vac, 60 Hz, Max. Current Draw @ NS = 1.07A
- » 120 Vac, 60 Hz, Max. Current Draw @ A = 1.905 A

4.1.21 24VDC Regulated/DC Common

This terminal is a 24 Volt (DC Power Output Range: 17.6 Volts to 24.6 Volts DC) DC regulated source of 1 Amp used for powering the printer. This source is Non-Power Limited.

4.1.22 24VDC Unregulated / DC Common

This terminal is not used and is for testing purposes only.

4.1.23 10Mbit Port

This port is used for additional monitoring (Optional) of the fire system and for initial setup of the fire system's database explained in section 2.0. (See Section 4.2.2, which shows

Monitoring)

4.1.24 Enclosure Door Hinge Relocation

The door of the CSimon enclosure is custom designed to be modified in the field from right-opening to left-opening. This is helpful in the event that a particular installation location does not allow for easy access from the standard setup. The door lock can also be easily relocated to the opposing side to complete the change.

To swap the hinge pin from the left side to the right, follow these steps:

1. Unlock the door with the provided key.
2. Using needle-nosed pliers, remove the Cotter pin from the top of the hinge. Place the Cotter pin in a secure area for reuse.
3. While holding the bottom edge of the door, grab the long hinge pin with needlenosed pliers and slide it up through the top of the enclosure until it has been completely removed.
4. With the hinge pin completely removed, the door will be free. Position the door against the enclosure as if it were closed.
5. Push the hinge pin into the top hole of the side you want the hinge to be located. Make sure it goes completely through both the enclosure hole and the corresponding door hole.
6. Carefully open the door and guide the hinge pin through the bottom door hole and bottom enclosure hole.
7. Push the pin down until it is completely secure. Approximately 1/16" of the hinge pin will still be exposed on the outside of the enclosure when complete.
8. Using the appropriate tools, remove the door lock and relocate to the opposing side. Ensure that the lock cam is positioned correctly to lock the door when shut.

4.2 System Diagrams

4.2.1 System Monitoring Diagram

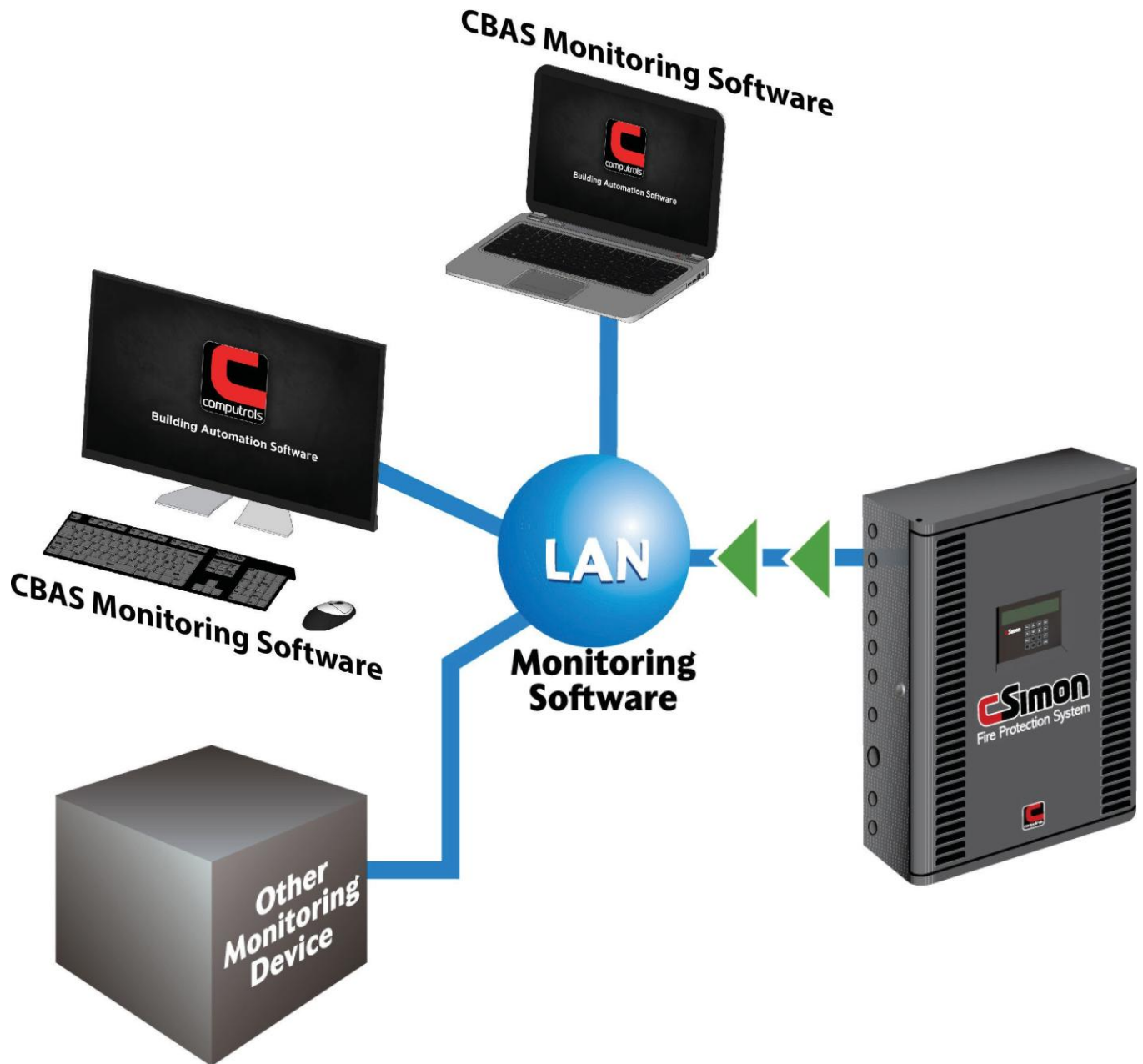

4.2.2 Installation/Wiring Diagram

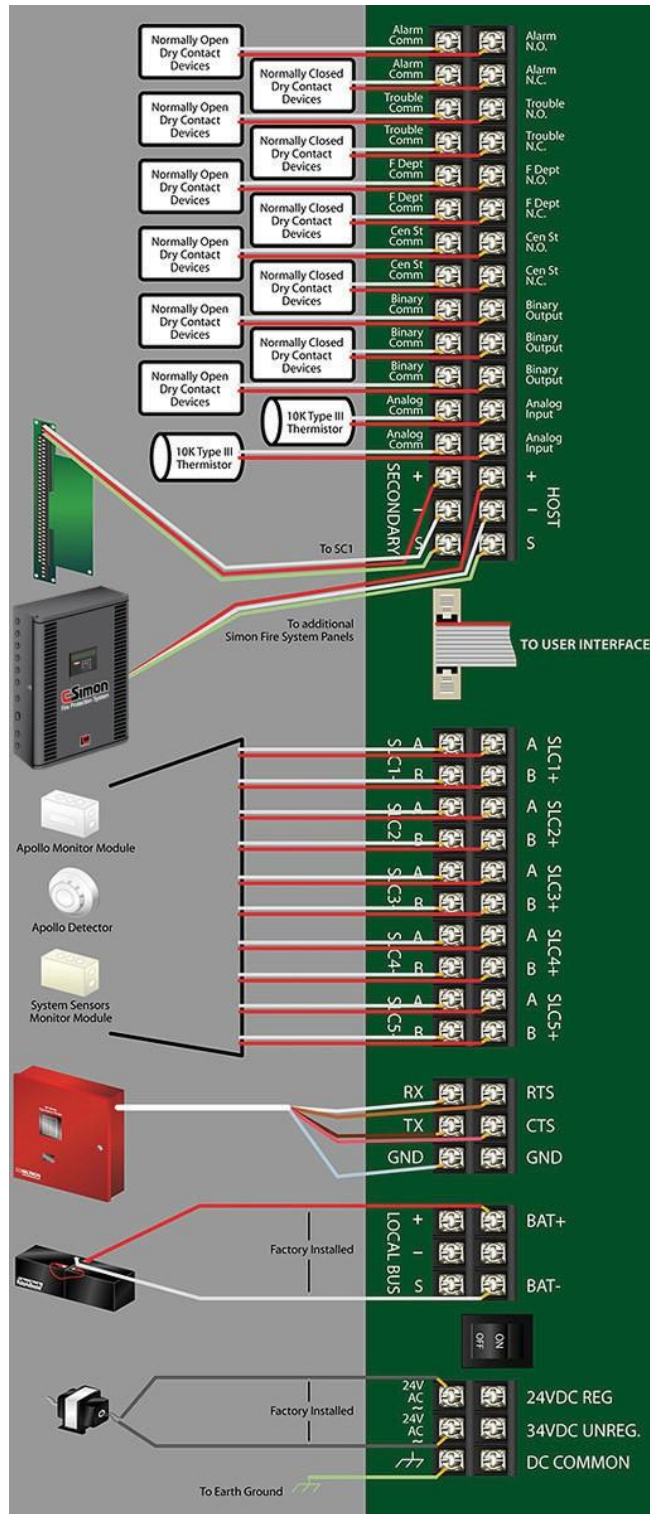

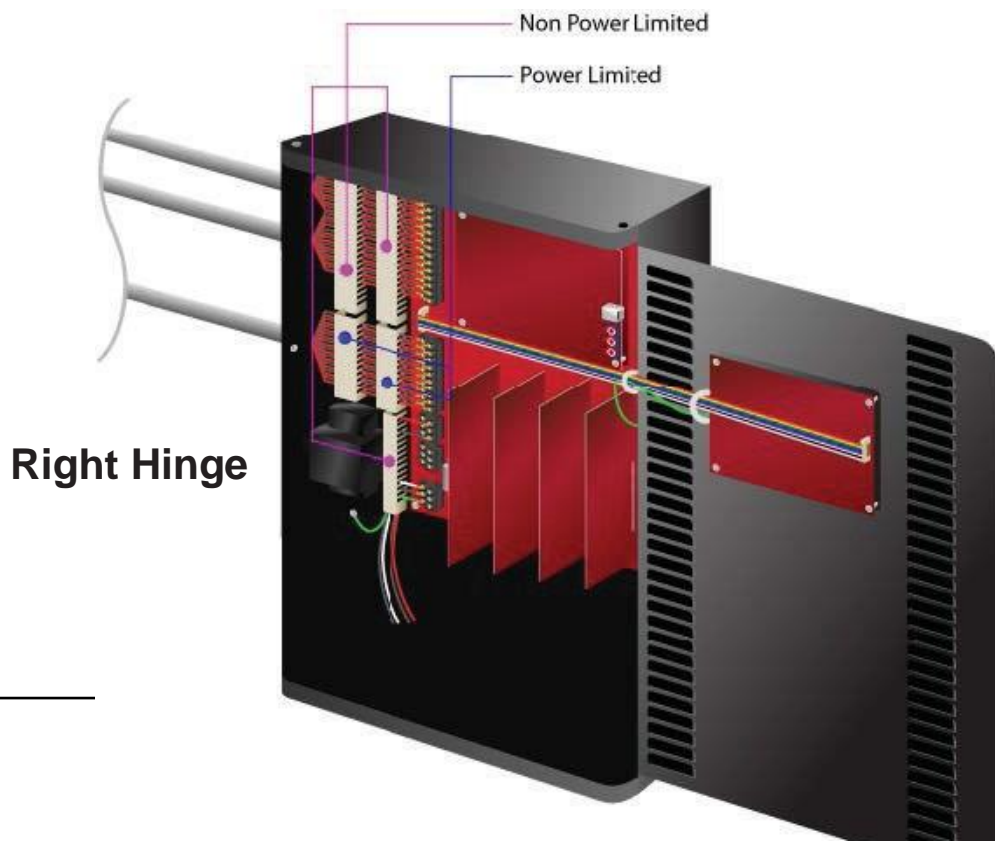
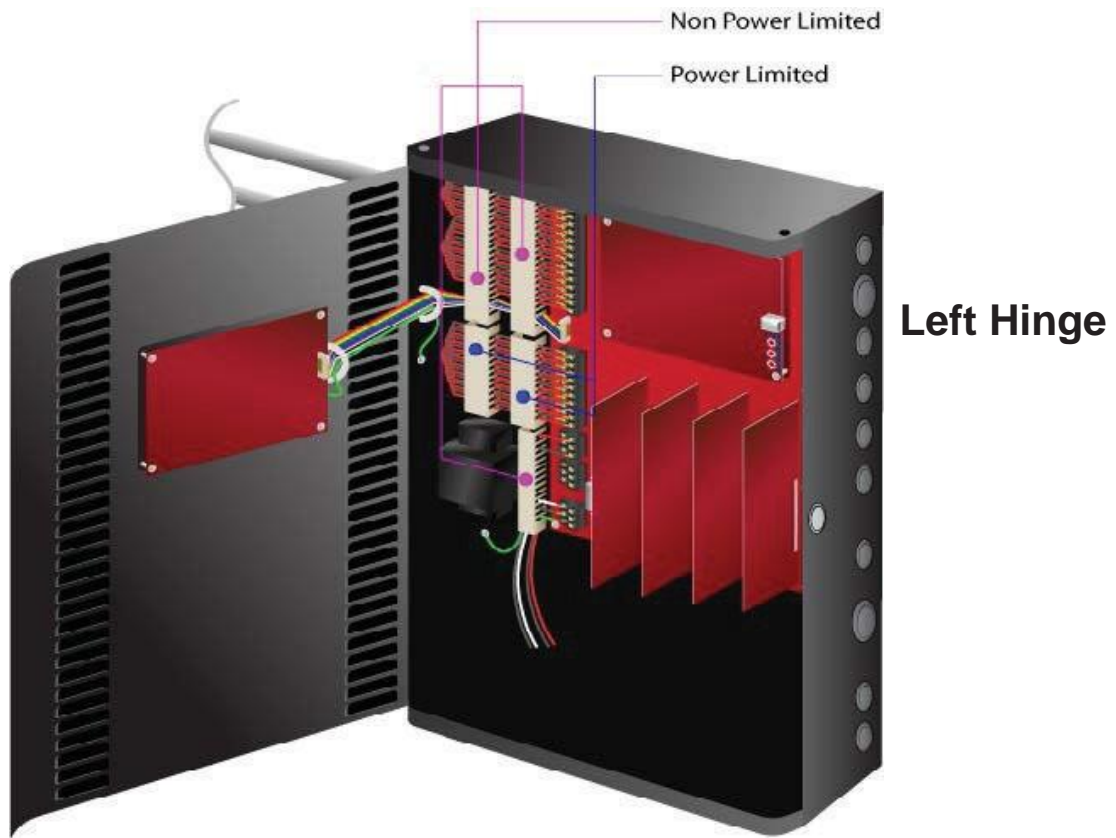

4.2.3 Sample Topologies

SAMPLE TOPOLOGY 1

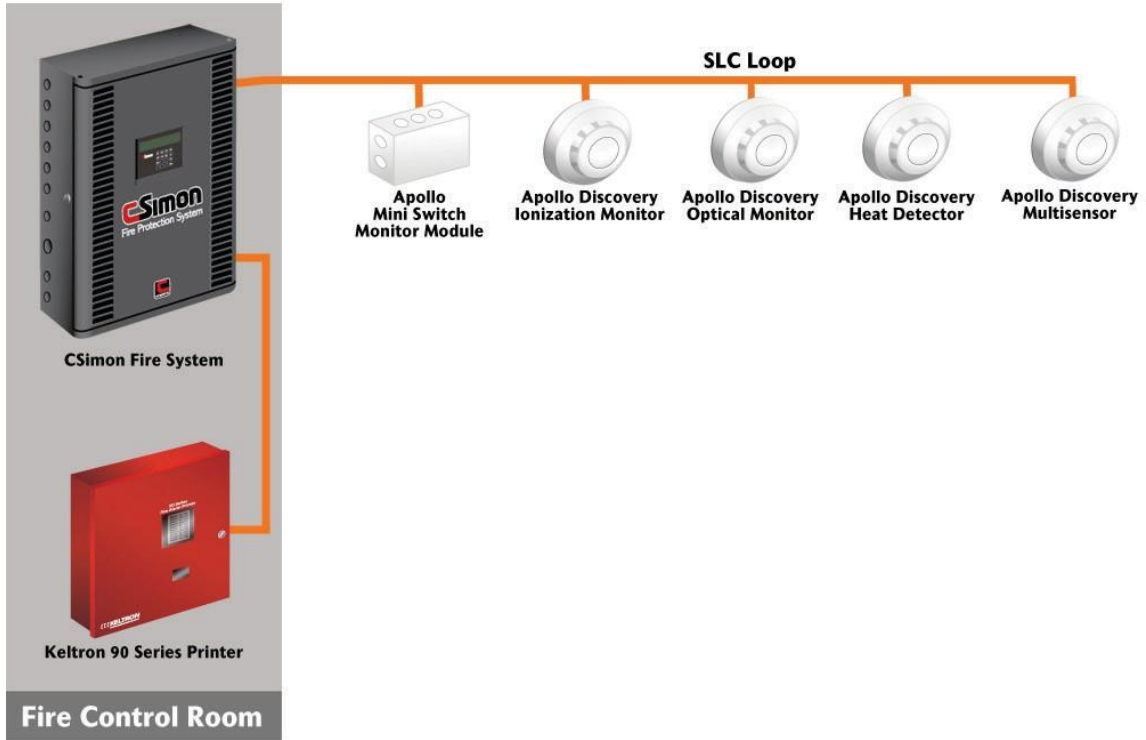

SAMPLE TOPOLOGY 2

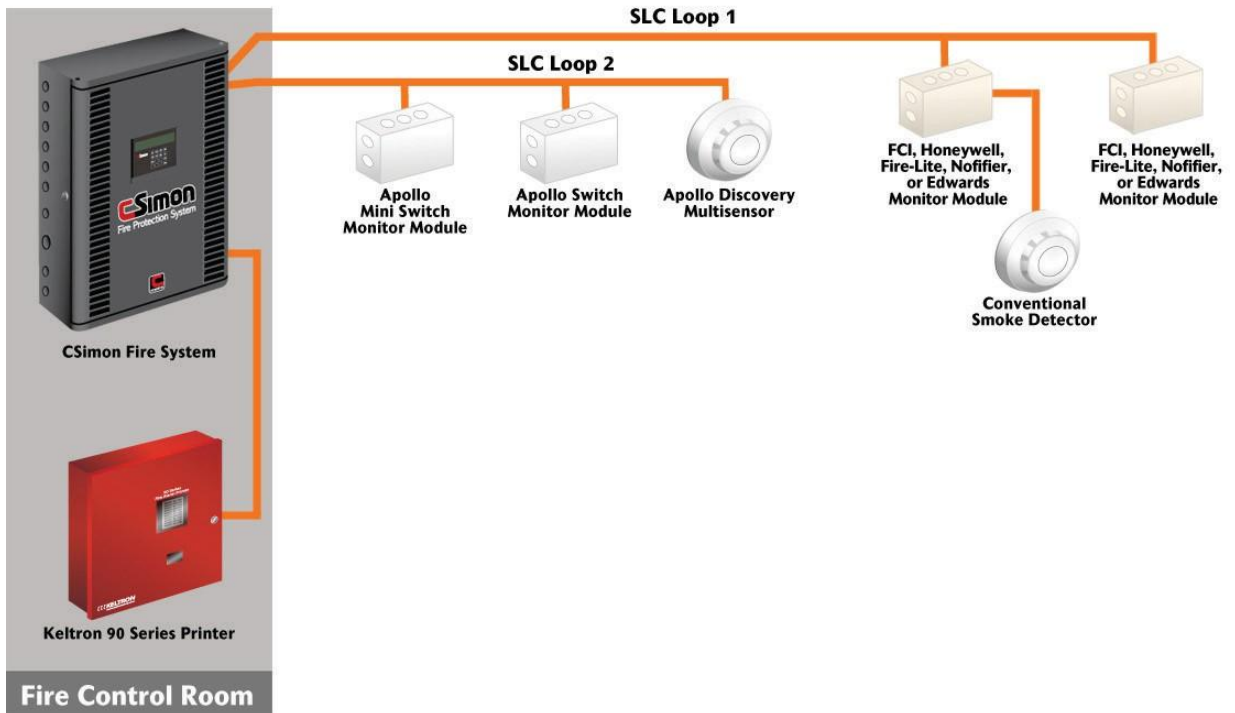

SAMPLE TOPOLOGY 3

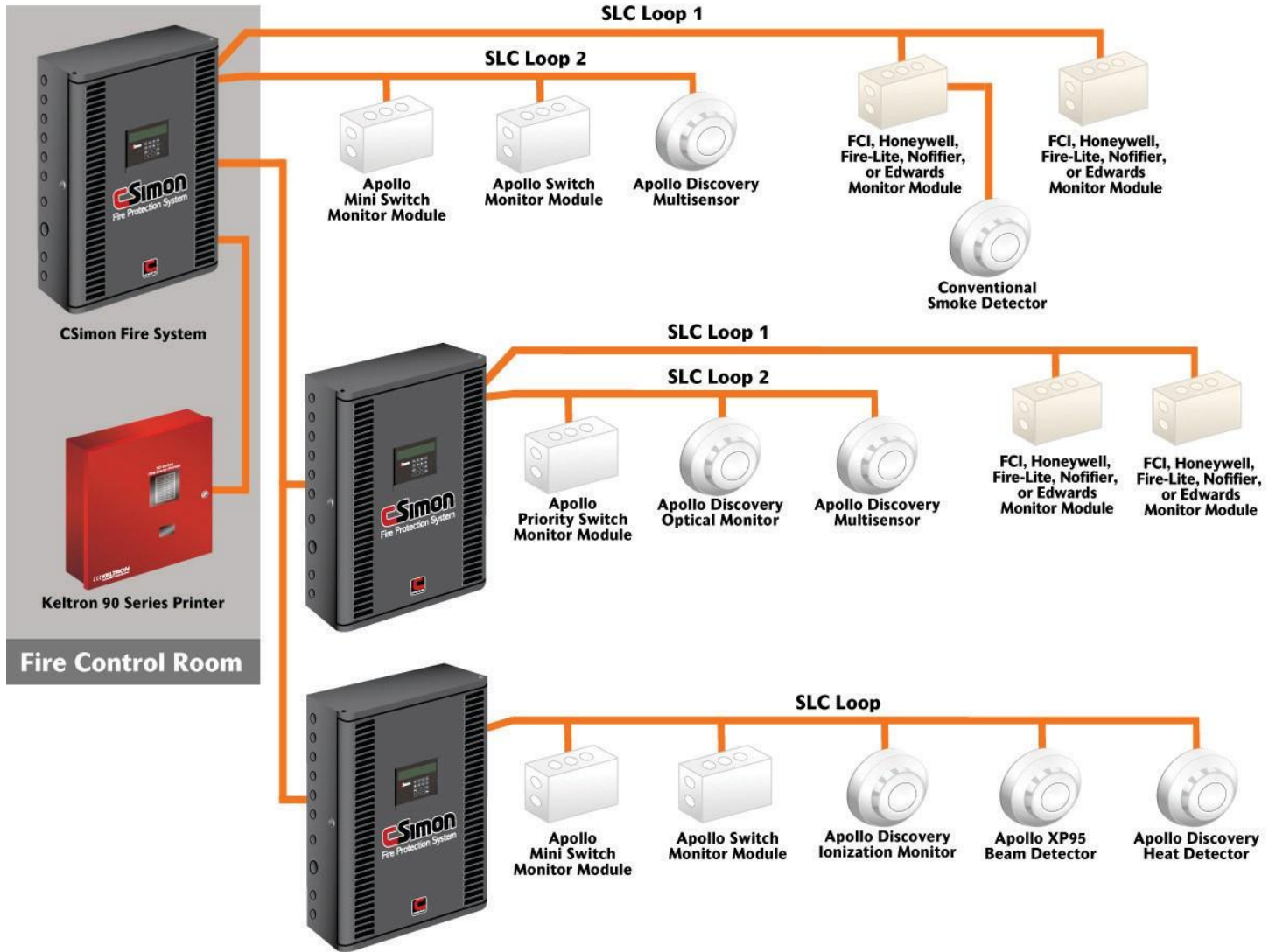

Section 5.0 >>

System Maintenance

5.1 Control Equipment

a) Functions

At a minimum, control equipment shall be tested to verify correct receipt of alarm, supervisory, and trouble signals (inputs), operation of evacuation signals and auxiliary functions (outputs), circuit supervision including detection of open circuits and ground faults, and power supply supervision for detection of loss of ac power and disconnection of secondary batteries.

b) Fuses

The rating and supervision shall be verified.

c) Interfaced equipment

Integrity of single or multiple circuits providing interface between two or more control panels shall be verified. Interfaced equipment connections shall be tested by operating or simulating operation of the equipment being supervised. Signals required to be transmitted shall be verified at the control panel.

d) Lamps and LEDs

Lamps and LEDs shall be illuminated.

e) Primary (main) power supply

All secondary (standby) power shall be disconnected and tested under maximum load, including all alarm appliances requiring simultaneous operation. All secondary (standby) power shall be reconnected at end of test. For redundant power supplies, each shall be tested separately.

5.2 Secondary (Standby) Power Supply

All primary (main) power supplies shall be disconnected and the occurrence of required trouble indication for loss of primary power shall be verified. The system's standby and alarm current demand shall be measured or verified and, using manufacturer's data, the ability of batteries to meet standby and alarm requirements shall be verified. General alarm systems shall be operated for a minimum of 5 minutes and emergency voice communications systems for a minimum of 15 minutes. Primary (main) power supply shall be reconnected at end of test.

5.3 Batteries

General Tests Prior to conducting any battery testing, the person conducting the test shall ensure that all system software stored in volatile memory is protected from loss.

- (a) Visual inspection Batteries shall be inspected for corrosion or leakage. Tightness of connections shall be checked and ensured. If necessary, battery terminals or connection shall be cleaned and coated. Electrolyte level in lead-acid batteries shall be visually inspected.
- (b) Battery replacement Batteries shall be replaced in accordance with the recommendations of the alarm equipment manufacturer or when the recharged battery voltage or current falls below the manufacturer's recommendations.
- (c) Charger test Operation of battery charger shall be checked in accordance with charger test for the specific type of battery.
- (d) Discharge test with the battery charger disconnected, the batteries shall be load tested following the manufacturer's recommendations. The voltage level shall not fall below the levels specified. Exception: An artificial load equal to the full fire alarm load connected to the battery shall be permitted to be used in conducting this test.
- (e) Load voltage test with the battery charger disconnected, the terminal voltage shall be measured while supplying the maximum load required by its application. The voltage level shall not fall below the levels specified for the specific type of battery. If the voltage falls below the level specified, corrective action shall be taken and the batteries shall be retested. Exception: An artificial load equal to the full fire alarm load connected to the battery shall be permitted to be used in conducting this test.

5.4 Battery Tests

Sealed lead-acid type

1. Charger test - With the batteries fully charged and connected to the charger, the voltage across the batteries shall be measured with a voltmeter. The voltage shall be 2.30 volts per cell ± 0.02 volts at 25°C (77°F) or as specified by the equipment manufacturer.
2. Load voltage test - Under load, the battery shall perform in accordance with the battery manufacturer's specifications.

5.5 Public Reporting System Tests

In addition to the tests and inspection required above, the following requirements shall apply. Manual tests of the power supply for public reporting circuits shall be made and recorded at least once during each 24-hour period. Such tests shall include the following:

- (1) Current strength of each circuit. Changes in current of any circuit exceeding 10 percent shall be investigated immediately.

- (2) Voltage across terminals of each circuit inside of terminals of protective devices. Changes in voltage of any circuit exceeding 10 percent shall be investigated immediately.
- (3) 2 Voltage between ground and circuits. If this test shows a reading in excess of 50 percent of that shown in the test specified in (2), the trouble shall be immediately located and cleared. Readings in excess of 25 percent shall be given early attention. These readings shall be taken with a calibrated voltmeter of not more than 100-ohms resistance per volt. Systems in which each circuit is supplied by an independent current source (Forms 3 and 4) require test between ground and each side of each circuit. Common current source systems (Form 2) require voltage tests between ground and each terminal of each battery and other current source.
- (4) Ground current reading shall be permitted in lieu of (3). If this method of testing is used, all grounds showing a current reading in excess of 5 percent of the supplied line current shall be given immediate attention.
- (5) Voltage across terminals of common battery, on switchboard side of fuses.
- (6) Voltage between common battery terminals and ground. Abnormal ground readings shall be investigated immediately.

Tests specified in (5) and (6) shall apply only to those systems using a common battery. If more than one common battery is used, each common battery shall be tested.

5.6 Transient Suppressors

Lightning protection equipment shall be inspected and maintained per the manufacturer's specifications. Additional inspections shall be required after any lightning strikes. Equipment located in moderate to severe areas outlined in NFPA 780, Standard for the Installation of Lightning Protection Systems, Appendix H, shall be inspected semiannually and after any lightning strikes.

5.7 Control Unit Trouble Signals

- (a) Audible and visual Operation of panel trouble signals shall be verified as well as ring-back feature for systems using a trouble-silencing switch that requires resetting.
- (b) Disconnect switches If control unit has disconnect or isolating switches, performance of intended function of each switch shall be verified and receipt of trouble signal when a supervised function is disconnected shall also be verified.
- (c) Ground-fault monitoring circuit If the system has a ground detection feature, the occurrence of ground-fault indication shall be verified whenever any installation conductor is grounded.
- (d) Transmission of signals to off-premises location

An initiating device shall be actuated and receipt of alarm signal at the off-premises location shall be verified.

A trouble condition shall be created and receipt of a trouble signal at the off-premises location shall be verified.

A supervisory device shall be actuated and receipt of a supervisory signal at the off premises location shall be verified. If a transmission carrier is capable of operation under a single- or multiple-fault condition, an initiating device shall be activated during such fault condition and receipt of a trouble signal at the off-premises location shall be verified, in addition to the alarm signal.

5.8 Conductors — Metallic

(a) Stray voltage

All installation conductors shall be tested with a volt/ohmmeter to verify that there are no stray (unwanted) voltages between installation conductors or between installation conductors and ground. Unless a different threshold is specified in the system installed equipment manufacturer's specifications, the maximum allowable stray voltage shall not exceed 1 volt AC/DC.

(b) Ground faults

All installation conductors other than those intentionally and permanently grounded shall be tested for isolation from ground per the installed equipment manufacturer's specifications.

(c) Short-circuit faults

All installation conductors other than those intentionally connected together shall be tested for conductor-to-conductor isolation per the installed equipment manufacturer's specifications. These same circuits also shall be tested conductor-to-ground.

(d) Loop resistance

With each initiating and indicating circuit installation conductor pair short-circuited at the far end, the resistance of each circuit shall be measured and recorded. It shall be verified that the loop resistance does not exceed the installed equipment manufacturer's specified limits.

(e) Supervision

Introduction of a fault in any circuit monitored for integrity shall result in a trouble indication at the control unit. One connection shall be opened at not less than 10 percent of the initiating devices, notification appliances and controlled devices on every initiating device circuit, notification appliance circuit, and signaling line circuit.

5.9 Conductors — Nonmetallic

(a) Circuit integrity

Each initiating device, notification appliance, and signaling line circuit shall be tested to confirm that the installation conductors are monitored for integrity in accordance with the requirements of Chapter 4 and Chapter 6.

(b) Fiber optics

The fiberoptic transmission line shall be tested in accordance with the manufacturer's instructions by the use of an optical power meter or by an optical time domain reflectometer used to measure the relative power loss of the line. This relative figure for each fiberoptic line shall be recorded in the fire alarm control panel. If the power level drops 2 percent or more from the value recorded during the initial acceptance test, the transmission line, section thereof, or connectors shall be repaired or replaced by a qualified technician to bring the line back into compliance with the accepted transmission level per the manufacturer's recommendations.

(c) Supervision

Introduction of a fault in any supervised circuit shall result in a trouble indication at the control unit. One connection shall be opened at not less than 10 percent of the initiating device, notification appliance, and signaling line circuit. Each initiating device, notification appliance,

and signaling line circuit shall be tested for correct indication at the control unit. All circuits shall perform as indicated in Table 6.5, Table 6.6.1, or Table 6.7.

5.10 Initiating Devices

(a) Fire extinguishing system(s) or suppression system(s) alarm switch - The switch shall be mechanically or electrically operated and receipt of signal by the control panel shall be verified.

(b) Fire-gas and other detectors - Fire-gas detectors and other fire detectors shall be tested as prescribed by the manufacturer and as necessary for the application.

(c) Heat detectors

1. Fixed-temperature, rate-of-rise, rate of compensation, restorable line, spot type (excluding pneumatic tube type) - Heat test shall be performed with a heat source per the manufacturer's recommendations for response within 1 minute. A test method shall be used that is recommended by the manufacturer or other method shall be used that will not damage the nonrestorable fixed-temperature element of a combination rate-of-rise/fixed-temperature element detector.
2. Fixed-temperature, nonrestorable line type - Heat test shall not be performed. Functionality shall be tested mechanically and electrically. Loop resistance shall be measured and recorded. Changes from acceptance test shall be investigated.
3. Fixed-temperature, nonrestorable spot type - After 15 years from initial installation, all devices shall be replaced or two detectors per 100 shall be laboratory tested. The two detectors shall be replaced with new devices. If a failure occurs on any of the detectors removed, additional detectors shall be removed and tested to determine either a general problem involving faulty detectors or a localized problem involving one or two defective detectors. If detectors are tested instead of replaced, tests shall be repeated at intervals of 5 years.
4. Nonrestorable (general) - Heat tests shall not be performed. Functionality shall be tested mechanically and electrically.
5. Restorable line type, pneumatic tube only - Heat tests shall be performed (where test chambers are in circuit) or a test with pressure pump shall be conducted.
6. Single- and multiple-station heat alarms - Functional tests shall be conducted according to manufacturer's instructions. Nonrestorable heat detectors shall not be tested with heat.

(d) Fire alarm boxes - Manual fire alarm boxes shall be operated per the manufacturer's instructions. Key-operated presignal and general alarm manual fire alarm boxes shall both be tested.

(e) Radiant energy fire detectors - Flame detectors and spark/ember detectors shall be tested in accordance with the manufacturer's instructions to determine that each detector is operative. Flame detector and spark/ember detector sensitivity shall be determined using any of the following:

- (1) Calibrated test method
- (2) Manufacturer's calibrated sensitivity test instrument
- (3) Listed control unit arranged for the purpose
- (4) Other approved calibrated sensitivity test method that is directly proportional to the input signal from a fire, consistent with the detector listing or approval. If designed to be field adjustable, detectors found to be outside of the approved range of sensitivity shall be replaced or adjusted

to bring them into the approved range. Flame detector and spark/ember detector sensitivity shall not be determined using a light source that administers an unmeasured quantity of radiation at an undefined distance from the detector.

(f) Smoke detectors

1. System detectors and single-station smoke alarms used in other than one- and two-family dwellings. The detectors shall be tested in place to ensure smoke entry into the sensing chamber and an alarm response. Testing with smoke or listed aerosol approved by the manufacturer shall be permitted as acceptable test methods. Other methods approved by the manufacturer that ensure smoke entry into the sensing chamber shall be permitted. Any of the following tests shall be performed to ensure that each smoke detector is within its listed and marked sensitivity range:
 - (1) Calibrated test method
 - (2) Manufacturer's calibrated sensitivity test instrument
 - (3) Listed control equipment arranged for the purpose
 - (4) Smoke detector/control unit arrangement whereby the detector causes a signal at the control unit when its sensitivity is outside its listed sensitivity range
 - (5) Other calibrated sensitivity test method approved by the authority having jurisdiction
2. Single- and multiple-station smoke alarms - Functional tests shall be conducted according to manufacturer's instructions.
3. Air sampling - Per manufacturer's recommended test methods, detector alarm response shall be verified through the end sampling port on each pipe run; airflow through all other ports shall be verified as well.
4. Projected beam type - The detector shall be tested by introducing smoke, other aerosol, or an optical filter into the beam path.
5. Smoke detector with built-in thermal element - Both portions of the detector shall be operated independently as described for the respective devices.
6. Smoke detectors with control output functions - It shall be verified that the control capability shall remain operable even if all of the initiating devices connected to the same initiating device circuit or signaling line circuit are in an alarm state.

(g) Initiating devices, supervisory

1. Control valve switch - Valve shall be operated and signal receipt shall be verified to be within the first two revolutions of the hand wheel or within one-fifth of the travel distance, or per the manufacturer's specifications.
2. High- or low-air pressure switch - Switch shall be operated. Receipt of signal obtained where the required pressure is increased or decreased a maximum 70 kPa (10 psi) from the required pressure level shall be verified.
3. Room temperature switch - Switch shall be operated. Receipt of signal to indicate the decrease in room temperature to 4.4°C (40°F) and its restoration to above 4.4°C (40°F) shall be verified.
4. Water level switch - Switch shall be operated. Receipt of signal indicating the water level raised or lowered 76.2 mm (3 in.) from the required level within a pressure tank, or 305 mm (12 in.) from the required level of a nonpressure tank, shall be verified, as shall its restoral to required

level.

5. Water temperature switch – Switch shall be operated. Receipt of signal to indicate the decrease in water temperature to 4.4°C (40°F) and its restoration to above 4.4°C (40°F) shall be verified.

(h) Mechanical, electrosonic, or pressure-type waterflow device - Water shall be flowed through an inspector's test connection indicating the flow of water equal to that from a single sprinkler of the smallest orifice size installed in the system for wet-pipe systems, or an alarm test bypass connection for dry-pipe, pre-action, or deluge systems in accordance with NFPA 25, Standard for the Inspection, Testing, and Maintenance of Water-Based Fire Protection Systems.

5.11 Special Hazard Equipment

- (a) Abort switch (special type) - Abort switch shall be operated. Correct sequence and operation in accordance with authority having jurisdiction shall be verified. Sequencing on as-built drawings or in owner's manual shall be observed.
- (b) Cross-zone detection circuit - One sensor or detector on each zone shall be operated. Occurrence of correct sequence with operation of first zone and then with operation of second zone shall be verified.
- (c) Matrix-type circuit - All sensors in system shall be operated. Development of correct matrix with each sensor operated shall be verified.
- (d) Release solenoid circuit - Solenoid shall be used with equal current requirements. Operation of solenoid shall be verified.
- (e) Verified, sequential, or counting zone circuit - Required sensors at a minimum of four locations in circuit shall be operated. Correct sequence with both the first and second detector in alarm shall be verified.
- (f) All above devices or circuits or combinations thereof - Supervision of circuits shall be verified by creating an open circuit.

5.12 Supervising Station Fire Alarm Systems — Receiving Equipment

(a) Digital alarm radio receiver (DARR) - The following conditions of all DARRs on all subsidiary and repeater station receiving equipment shall be caused. Receipt at the supervising station of correct signals for each of the following conditions shall be verified:

- (1) AC power failure of the radio equipment
- (2) Receiver malfunction
- (3) Antenna and interconnecting cable failure
- (4) Indication of automatic switchover of the DARR
- (5) Data transmission line failure between the DARR and the supervising or subsidiary station

(b) McCulloh systems - The current on each circuit at each supervising and subsidiary station under the following conditions shall be tested and recorded:

- (1) During functional operation

(2) On each side of the circuit with the receiving equipment conditioned for an open circuit

A single break or ground condition shall be caused on each transmission channel. If such a fault prevents the functioning of the circuit, receipt of a trouble signal shall be verified. Each of the following conditions at each of the supervising or subsidiary stations and all repeater station radio transmitting and receiving equipment shall be caused; receipt of correct signals at the supervising station shall be verified:

- (1) RF transmitter in use (radiating)
- (2) AC power failure supplying the radio equipment
- (3) RF receiver malfunction
- (4) Indication of automatic switchover

(c) Radio alarm supervising station receiver (RASSR) and radio alarm repeater station receiver (RARSR) - Each of the following conditions at each of the supervising or subsidiary stations and all repeater station radio transmitting and receiving equipment shall be caused; receipt of correct signals at the supervising station shall be verified:

- (1) AC power failure supplying the radio equipment
- (2) RF receiver malfunction
- (3) Indication of automatic switchover, if applicable

(d) Private microwave radio systems - Each of the following conditions at each of the supervising or subsidiary stations and all repeater station radio transmitting and receiving equipment shall be caused; receipt of correct signals at the supervising station shall be verified:

- (1) RF transmitter in use (radiating)
- (2) AC power failure supplying the radio equipment
- (3) RF receiver malfunction
- (4) Indication of automatic switchover